

Rinnai

Energysaver® Space Heaters

Models: RHFE-309FT & RHFE-559FT

Operation and Installation Manual

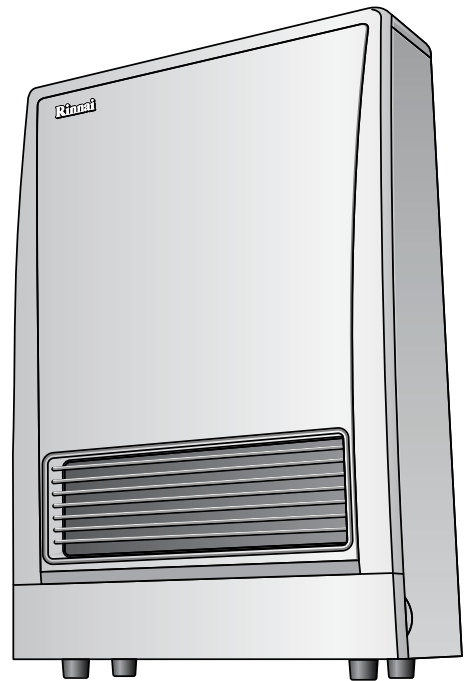
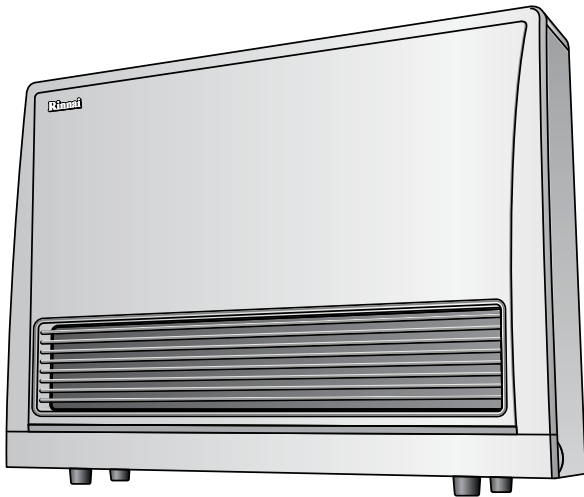

Models:

RHFE-309FT

RHFE-559FT

Please note:

**Flue System Installation Instructions
enclosed with Flue Terminal packaged
separately.**

This appliance shall be installed in accordance with:

- Manufacturer's Installation Instructions
- Local Gas Fitting Regulations
- Municipal Building Codes
- AS 5601 Gas Installations, AS/NZS 3000 Wiring Rules
- Any other relevant Statutory Regulations

This appliance must be installed, serviced and removed by an authorised person.



The Australian
Gas Association
All Rinnai gas products
are A.G.A. certified.



N10378



**Quality
Endorsed
Company**

ISO 9001 Lic 4983
SAI Global

Head Office Certified

Distributed and serviced in Australia under a Quality
System certified as complying with ISO 9001 by
SAI Global

INSTALLATION REQUIREMENTS

This heater must be installed by an authorised person. The installation must conform to local regulations.

The installation must also comply with the instructions supplied by Rinnai.

Service and removal must be carried out by an authorised person.

CERTIFICATION

The Rinnai Energysaver® Range have been certified by the Australian Gas Association.

The AGA Certification Number is shown on the appliance dataplate.

No parts or functions should be modified or permanently removed from the heater.

Please keep these instructions in a safe place for future reference.

CARTON CONTENTS

Check you have the following:

1 x Rinnai Space Heater - RHFE-309FT or RHFE-559FT

1 x Rear Cover set, comprising of left, right and top cover panels

1 x Bolt pack containing;

- Stainless steel sheath clamp
- 2 x securing brackets
- 2 x 8g x 30 mm stainless steel securing bracket screws
- 2 x plastic inlet hose clamps
- 1 x 150 mm long cable tie
- 1 x HD stainless steel flue clamp
- 2 x 6g x 10 mm button head screws
- 4 x 6g x 8 mm pan head screws.

TABLE OF CONTENTS

INSTALLATION REQUIREMENTS	i
CERTIFICATION	i
CARTON CONTENTS	i
ABOUT YOUR ENERGYSAVER®	1
Control Panel Layout	1
SAFETY	2
Important	2
FEATURES	7
CUSTOMER INFORMATION - OPERATION	8
To turn the unit 'ON'	8
To turn the unit 'OFF'	8
Room Temperature Adjustment	8
Economy Mode	9
Child Lock / Function Lock	9
Fan Operation	9
SETTING THE CLOCK	10
Setting the Clock/Timers	10
Day light saving and time adjustment	10
Setting the ON / OFF Timers	10
OPERATING THE TIMERS	11
Operating the Timers	11
Set and Forget Operation	11
Override	11
OTHER OPERATING INFORMATION	12
Pre-Heat	12
Humidifier Tray	12
Vertical Louvre Adjustment	12
Outside Flue Terminal	12
CARE OF YOUR ENERGYSAVER®	13
Cleaning	13
Fan Filter	13
SAFETY DEVICES	14
Overheat Switch:	14
Fusible Links:	14
Flame Failure Device:	14
Electrical Fuse:	14
Power Failure:	14
SERVICE	14
INSTALLATION MANUAL - TABLE OF CONTENTS	16
CONTACT INFORMATION	29

ABOUT YOUR ENERGYSAVER®

Control Panel Layout - RHFE-309FT / RHFE-559FT

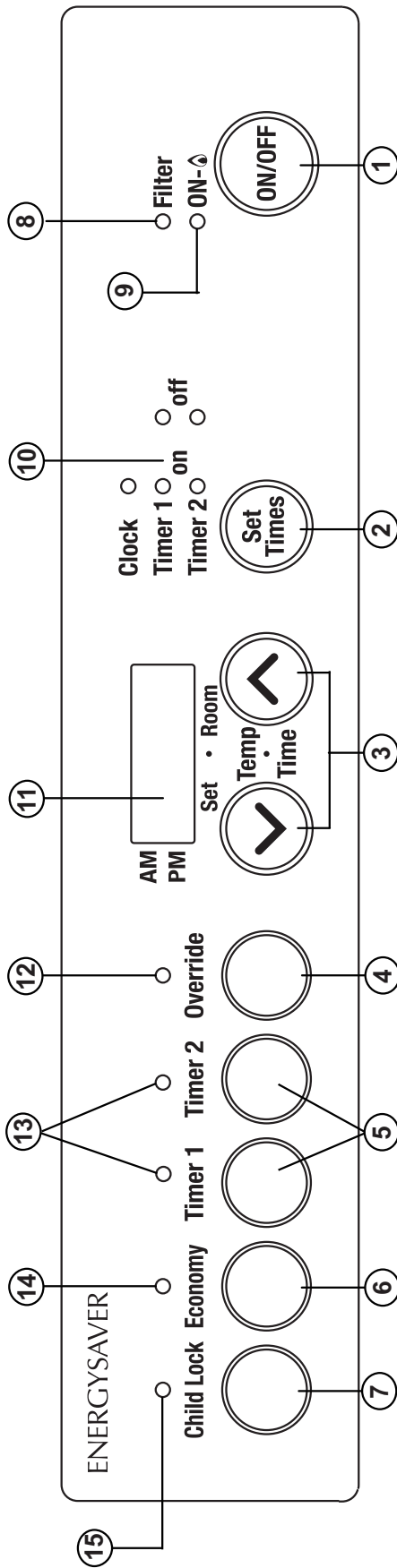

- | | | | | |
|---|---|---|---|--|
| <p>1 'ON' / 'OFF' BUTTON</p> <p>Main switch for turning 'ON' / 'OFF'.</p> | <p>2 SET TIMES BUTTON</p> <p>Selects clock and/or Timers for adjusting or programming.</p> | <p>3 TIME / TEMP ADJUSTMENT BUTTON</p> <p>Increases or decreases the temperature setting as well as changing hours or minutes.</p> | <p>4 OVERRIDE BUTTON</p> <p>Temporarily changes operation from ON to OFF or OFF to ON, until next programmed setting is reached.</p> | <p>5 ON TIMER BUTTON</p> <p>Selects operating mode for Timers 1 & 2.</p> |
| <p>6 ECONOMY BUTTON</p> <p>Selects energy saving function.</p> | <p>7 CHILD LOCK BUTTON</p> <p>Locks all controls when pressed. (EXCEPT OFF)</p> | <p>8 FILTER INDICATOR</p> <p>Indicates that the filter needs cleaning.</p> | <p>9 POWER ON / COMBUSTION INDICATOR</p> <p>Indicates that the appliance is turned ON and whether the burner is alight.</p> | <p>10 CLOCK ADJUSTMENT & TIMER INDICATORS</p> <p>Indicates that clock or dual timer programme is being set.</p> |
| <p>11 TIME / TEMP DISPLAY</p> <p>Shows either the time of day, temperatures, or coded error message.</p> | <p>12 OVERRIDE INDICATOR</p> <p>Indicates that the override function is activated.</p> | <p>13 TIMER INDICATOR</p> <p>Indicates that Timer 1 or Timer 2 has been selected to operate.</p> | <p>14 ECONOMY INDICATOR</p> <p>Indicates that the Economy mode is in operation.</p> | <p>15 CHILD LOCK INDICATOR</p> <p>Indicates Child lock is activated.</p> |

SAFETY

Important

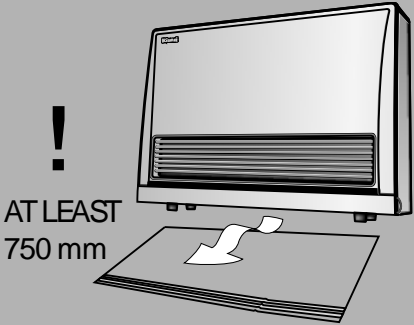

1. The appliance must be installed in accordance with the local gas and electrical authority regulations.
 2. **DO NOT** connect to an LPG Gas cylinder indoors.
 3. A dedicated 240 V earthed 10 Amp power point must be used with this appliance.
 4. Heat emanating from the front of this appliance may over time affect the appearance of some materials used for flooring such as carpet, vinyl, cork or timber. This effect may be amplified if the air in the room contains cooking vapours or cigarette smoke. To avoid this possibility, it is recommended that a mat is placed in front of the appliance, extending at least 750 mm in front of the air outlet.
- 
5. The appliance is not intended for use by young children or infirm persons without supervision.
 6. This appliance is not intended for use by persons (including children) with reduced physical, sensor or mental capabilities, or lack of experience and knowledge, unless they have been given supervision or instructions concerning use of this appliance by a person responsible for their safety.
 7. Young children should be supervised to ensure they do not play with the appliance.
 8. If the supply cord is damaged or require replacing, it must be replaced by the manufacturer or the manufacturer's agent or similarly qualified person in order to avoid a hazard.
 9. **DO NOT** modify this appliance. Modifying it in any way or form, from original specifications may create a dangerous situation and will void your warranty.

Unpack the heater and check for damage. **DO NOT INSTALL DAMAGED HEATER.** If the heater is damaged, contact your supplier for advice. Before installing the heater, check the label for the correct gas type (refer rating plate, right hand side panel).

Refer to local gas authority for confirmation of the gas type if you are in doubt.

Important Points

1. The appliance must be installed in accordance with the local gas and electrical authority regulations.
2. For information on gas consumption, refer technical specifications on page 17 and check with the data plate on the appliance.
3. This appliance must not be installed where curtains or other combustible materials could come into contact with it. In some cases curtains may need restraining.
4. Heater must not be located below a power socket-outlet.
5. The local gas and electrical authorities will be able to advise on local regulations.
6. Only the approved flue components specified by Rinnai must be used.

SAFETY

DO NOT allow children to post articles in the louvres.

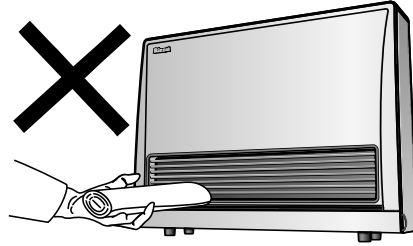

The appliance is not intended for use by young children or infirm persons without supervision.

Young children should be supervised to ensure they DO NOT play with the appliance.

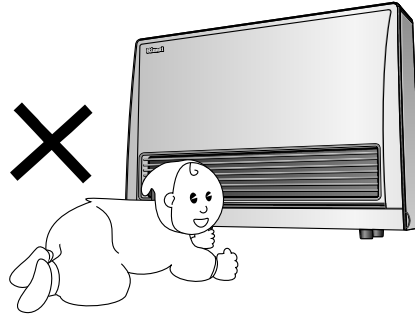

DO NOT allow children or elderly persons to sleep in the warm air discharge from the heater.

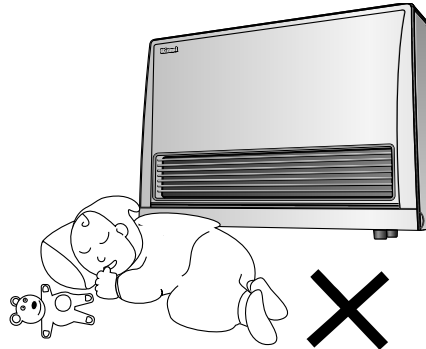

DO NOT cover or place articles on or against this heater.

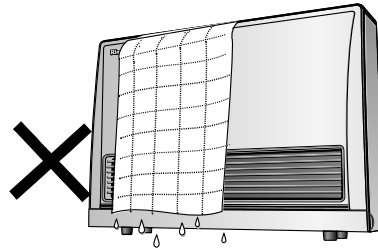

Turn 'OFF' heater after use.



SAFETY

Keep away from flammable materials.
Combustible materials must not be placed where the heater could ignite them.

DO NOT place articles on or against this appliance.

DO NOT use or store flammable materials near this appliance.

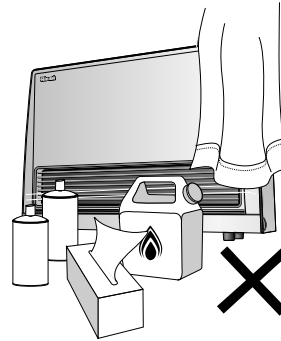

DO NOT spray aerosols in the vicinity of this appliance while it is in operation.

Most aerosols contain butane gas which can be a fire hazard if used near this heater when it is in use.

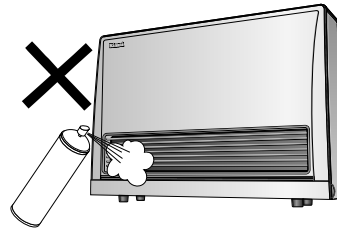

DO NOT sit on this heater.

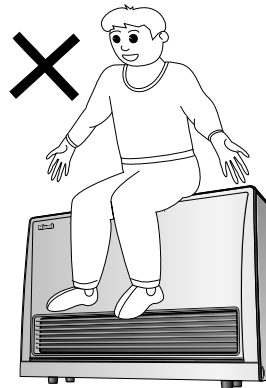

DO NOT place articles in front of the louvres.

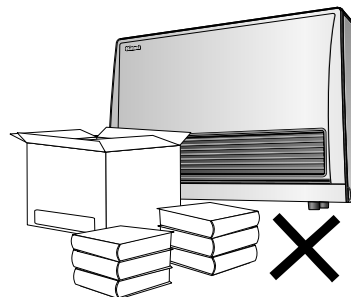

DO NOT unplug the heater while it is in operation or while the fans are still cycling.

DO NOT turn the heater 'OFF' by unplugging it from the wall.

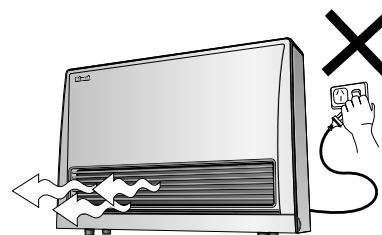

SAFETY

DO NOT place containers of liquid on top of the heater. Water spillage can cause extensive damage to the appliance and may result in electric shock.

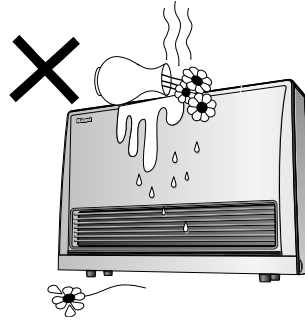

A dedicated 240V earthed 10 Amp power point must be used with this appliance. DO NOT use power boards or double adaptors to operate this appliance. Heater must not be located below a power socket-outlet.

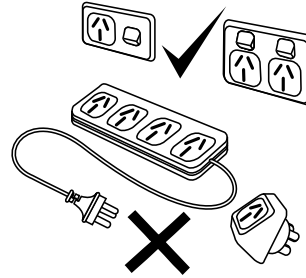

This appliance must not be built-in. The clearances shown must be maintained.

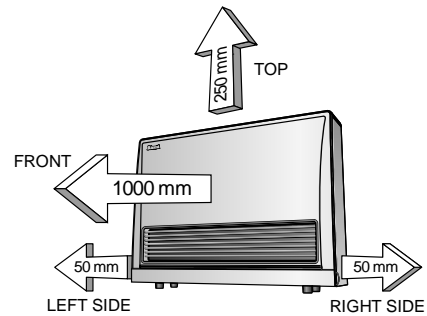

Access panel and Humidifier tray have to be fitted while the heater is in use.

Rinnai recommend you fill the tray to the water level indicator as marked. Take care not to overfill.

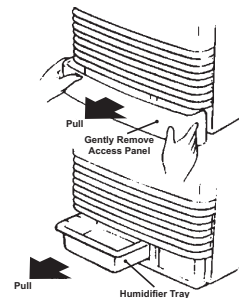

Heat emanating from the front of this appliance may over time affect the appearance of some materials used for flooring such as carpet, vinyl, cork or timber. This effect may be amplified if the air in the room contains cooking vapours or cigarette smoke. To avoid this possibility, it is recommended that a mat be placed in front of the appliance, extending at least 750 mm in front of the air outlet.

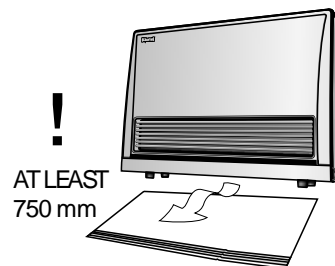

SAFETY

During peak operating periods the filters should be cleaned weekly, however if the "FILTER" warning indicator flashes in the control panel display, turn off the appliance immediately and clean filters before further use.

○ Filter

○ ON-△



When the heater is operated for the first time or after long periods of non use a slight odour may be emitted, this is normal.

However if odours persist switch 'OFF' the appliance and contact Rinnai.

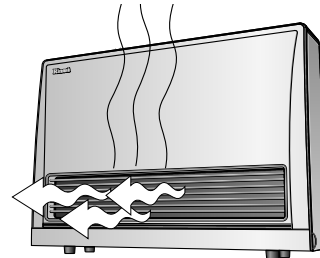

Keep flammable materials, trees shrubs etc. away from the flue terminal.



Snow Areas - in areas subject to heavy snowfall, keep snow clear of flue terminal at all times.

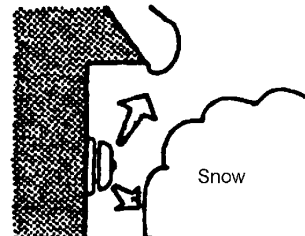

FEATURES

ROOM SEALED

Air for combustion is taken from the outside and the flue product are exhausted to the outside. This means heater operation has no effect on the composition and quality of air in the room.

PUSH BUTTON IGNITION

Only one touch of the 'ON'/'OFF' button is required to operate the heater.

FUNCTION / CHILD LOCK

Prevents children from altering heater settings whilst running, or from activating the heater when turned 'OFF'.

MEMORY

The micro-computer records selected preset temperatures, the times programmed into Timers as well as operating the Economy/Auto-Off and Pre-heat modes, to maintain comfort levels.

7 STEP AUTOMATIC HEAT CONTROL

Selected temperature is controlled via thermostat. The optimum corresponding fan speeds are controlled by the Central Processing Unit.

PRE-HEAT

This function will automatically operate the appliance before the programmed start time of the Timer, in order to heat a room to the pre-set temperature **by** the programmed start time.

ECONOMY MODE

The Economy (ECON) function is an energy saving features designed to control the room temperature and prevent discomfort from over heating.

OVERRIDE FUNCTION

This temporarily changes the heater operation from 'ON' to 'OFF', or vice versa, until the next programmed setting is reached.

DUAL WEEKDAY / WEEKEND TIMER

The Dual WEEKDAY/WEEKEND Timer allows you to program the appliance to come on for two separate periods each day, one period in the morning and one period in the evening. The built in Pre-heat Mode brings the room temperature to the temperature you have selected, by the time programmed into the Timer.

The Dual Timer feature means that you can "Set and Forget" your heater. It will turn itself 'ON' or to STANDBY at the times you have programmed until you cancel the Timer program.

FILTER INDICATOR

When the fan filters become covered with dust, the filter indicator will flash. The filters should be vacuumed at regular intervals to avoid unnecessary strain on the appliance.

HUMIDIFIER TRAY

The integral **humidifier tray** can be filled with water as required to raise the humidity level in the room for extra comfort. Tray should not be filled to more than 3/4 full.

CUSTOMER INFORMATION - OPERATION

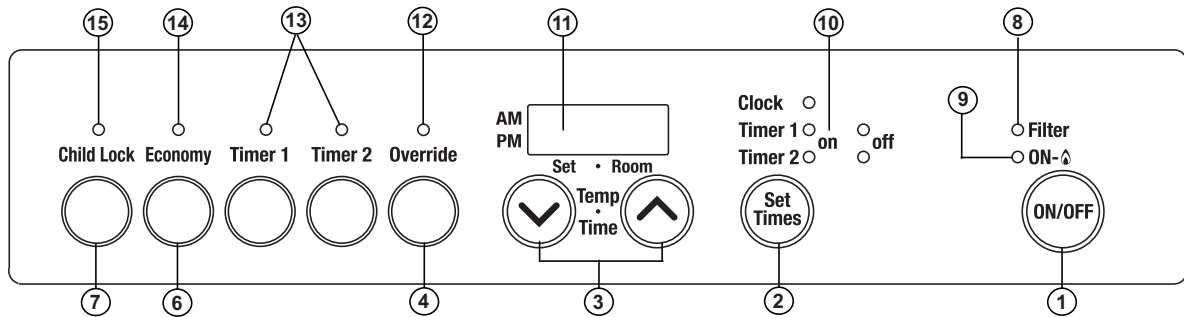

You must read and understand these instructions fully before operating the heater.

To turn the unit 'ON' ①

Press the 'ON'/'OFF' ① button to operate the heater. The 'ON' indicator ⑨ will glow green. The spark generator will be heard before the burner ignites and the 'ON' indicator ⑨ glows red, indicating that the heater is alight.

When the heater warms up, the fan will automatically start.

If the heater does not ignite on initial use, this may be due to air remaining in the gas supply line. The spark generator will only continue for 15 seconds. After this it will be necessary to press the 'ON'/'OFF' ① button 'OFF', then 'ON' again.

If the appliance fails to ignite after 4 attempts, contact Rinnai as a service call may be required.

To turn the unit 'OFF' ①

Simply press the 'ON'/'OFF' ① button to switch 'OFF' the heater. The 'ON' indicator ⑨ light will go out. The Fan will continue to operate for several minutes after the burner has gone out in order to cool the appliance. Do not unplug the appliance while the fan is running.

Room Temperature Adjustment ③

The room temperature and pre-set temperatures can only be displayed and adjusted when the heater is running.

Press the "∧" ③ button to increase the temperature setting or "∨" ③ button to decrease the temperature setting.

The temperatures can be preset to:

- [L] - Temperature is controlled at set temperature "Low".
- [16°C] to [26°C] in 1°C steps - thermostatic control to preset temp selected. Combustion rate varies as required to maintain the selected temperature.
- [H] - continuous combustion on 'High'.



Room temperature on the TIME/TEMP Display ⑪ may vary slightly from the actual room temperature.

If the heater does not ignite then the pre-set temperature may not be set to a setting which is higher than the room temperature. The 'ON' indicator ⑨ will change colour from red to green when the heater reaches the pre-set temperature and stops running.

CUSTOMER INFORMATION - OPERATION

Economy Mode ⑥

The Economy (ECON) function is an energy saving features designed to control the room temperature and prevent discomfort from over heating.

- When the room temperature reaches the set temperature, the set temperature decrease at the rate of 1°C per 30 minutes in two cycles.
- The set temperature on the display does not change.
- Room temperature may not decrease in some cases, this is depending on room style, location of the appliance and the temperature outside the room.

Child Lock / Function Lock ⑦

The Child Lock function will help to prevent accidental operation as well as prevent small children from altering the controls. To operate the Child Lock simply press the Child Lock ⑦ button. The function is activated immediately and the Child Lock indicator ⑮ will glow.

To Deactivate the Child Lock simply press the Child Lock ⑦ button for 2 seconds and the Child Lock indicator ⑮ will go out. The Child Lock can be deactivated at any time in this way.

During normal operation the Child Lock may be activated and all controls, other than the 'OFF' switch, will be locked. Deactivating the Child Lock releases the controls. If the Child Lock is activated whilst the heater is turned 'OFF', then all functions will be locked. If the heater is turned 'OFF' while the Child Lock is activated, it cannot be turned 'ON' again until the Child Lock is deactivated.

Fan Operation

The fan turns 'ON' automatically when the heat exchanger warms up and off when it cools down. This helps to prevent cold draughts and maximises efficiency.

1. The Economy mode can only be operated when the heater is turned 'ON', but remains in the system memory until deactivated.
Select the Economy mode **before** selecting timer operation.
2. Press the Economy ⑥ button to start the Economy function. The Economy indicator ⑭ will glow.
3. Press the Economy ⑥ button once more to switch 'OFF' the economy function.

SETTING THE CLOCK

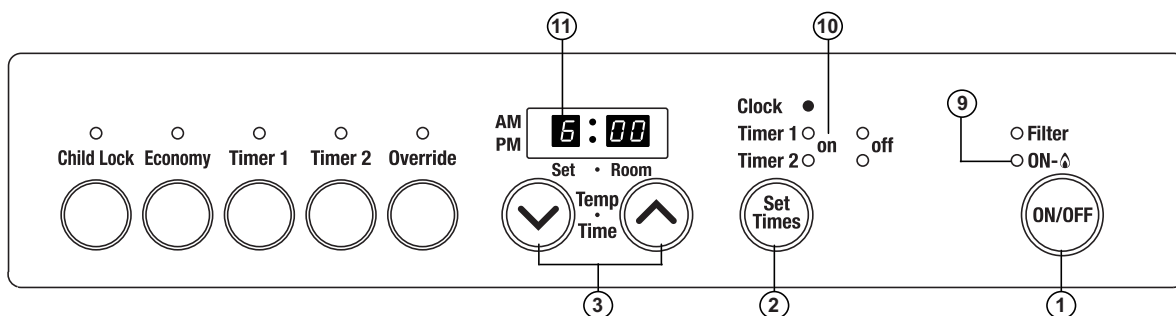

Setting the Clock/Timers

When the appliance is first plugged in or after a power failure, the Digital Display (11) will show ---:--

As an example, let's set the clock to 10:35 am;

1. Press the Set Times (2) button once, the Clock/Timer indicator (10) will flash.
2. Press and hold the “^” (3) button; the minutes will begin to change first then the time will change by whole hours.
3. Release the button when AM 10:00 shows on the Digital Display (11). Confirm that you have selected AM, a small indicator on the left hand side of the Digital Display indicates the AM setting.
4. Press and hold the “^” (3) button again, release the button when AM 10:35 shows. If you go past AM 10:35, then the “v” (3) button can be used to change the time settings in reverse.
5. Press the Set Times (2) button five times to lock in and complete setting the time. The Clock and Timer indicators will go out. A small indicator on the Digital Display (11) will flash to show that the Clock is operating.
6. The display will dim approximately 10 seconds after the last control.

Day light saving and time adjustment

- Follow steps 1 to 5 to adjust for day light saving and for time adjustment.

Setting the ON / OFF Timers



Before programming the Timers you must ensure that the clock has been set to the correct time.

NOTE

Example: programming Timer 1 to heat the room by 7:10 am and finish at 9:00 am.

1. Press the Set Timers (2) button twice. The Digital Display (11) will show AM 6:00. The Clock/Timer indicator (10) will flash.
2. Press the “^” (3) button until AM 7:00 appears, release the button, then press it again until AM 7:10 appears. (Press the “v” (3) button if you go past AM 8:00).
3. Press the Set Timers (2) button again, the Timer 1 'OFF' indicator will flash. Press the “^” button until AM 9:00 appears.
4. Press the Set Timers (2) button three times to lock in the program time. The Digital Display (11) will show the current time. A small indicator on the Digital Display (11) will flash to show that the display has returned to the clock.
5. Timer 2 is programmed in the same way. Remember to ensure that the Timer indicator (10) is flashing when you programming in the desired setting.



This procedure is for setting the 'ON' / 'OFF' times for Timers. To program the time periods refer page 11.

If during setting no buttons are pressed for 1 minute the setting sequence will automatically cancel and the display will revert to normal display.

OPERATING THE TIMERS

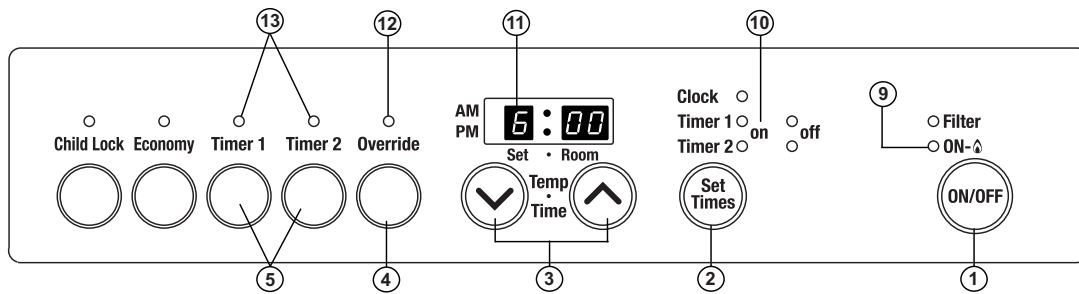

Operating the Timers

The timers can be programmed to operate for any two time periods in any 24 hours. Before operating the Timer(s), the clock time must be correct and a starting time and finishing time for the Timer(s) must be programmed. The two Timers operate in the same way. This heater does not commence operation at the programmed starting time. It will attempt to heat a room **by** the programmed starting time. Refer to “Pre-Heat” on page 12, for further explanation.

To select the Timer(s) to commence heating:

- Set Times ② button and check the time shown on the Digital Display ⑪ is correct. Press the Set times ② button to finish flashing on the timer indicator(s). ⑩
- Check the ON and OFF times, for both Timers if necessary, (refer to ‘setting the ‘ON’/‘OFF’ timers’).
- Press the ON/OFF ① button to operate the heater without the clock / timer indicator ⑩ flashing. The ‘ON’ indicator ⑨ will glow green.
- Select the desired temperature setting. ③

Press the Timer 1 and/or Timer 2 ⑤ button(s). The timer indicator(s) ⑬ will glow. The heater will now remain on standby until up to one hour prior to the time programmed into the selected Timer(s) is reached. Timer indicator also flash during Pre-heat (Combustion). When this time is reached, the Timer indicator will flash and the heater will operate. The ‘ON’ indicator ⑨ glows red when the heater commences operation. Actual start time will depend on temperature selected and current room temperature. (Refer to Pre-heat section for details).

Set and Forget Operation

Your heater can be operated to alternate between Timers automatically during cold whether by selecting Timer 1 and Timer 2 ⑤ button together. Both Timer indicator(s) ⑬ will glow. The appliance will remain on standby at intervals between the programmed finishing and starting times of each Timer. While the heater is operating during programmed intervals the Timer indicator(s) ⑬ will flash.



If there is a power failure, the system memory will retain the Timer programs, and the clock will stop at the time the power goes off. The clock will re-start again when the power comes back on, but the time will be slow by the duration of the power failure. To set the clock to the correct time after the power has come back on, simply follow the instructions on “SETTING THE CLOCK” on page 10.

Override

This function is intended to be used to manually override the current operation of the heater. For example; if the heater is in standby mode (i.e. between finishing time and starting time of a Timer) and the Override ④ button is selected, then the heater will begin to operate and heat the room.

To operate the Override simply press the Override ④ button. The Override ⑫ indicator will flash. To manually deactivate the Override simply press the Override ④ button again. The Override ⑫ indicator will go out, and the heater will return to standby mode. The heater will continue to operate on Override until the Override button is pressed again, or one of the Timers takes over the operation of the appliance. This means that the Override mode will automatically drop out if a programmed starting time is reached.

The appliance will then return to operating at the times programmed into the Timer(s).

OTHER OPERATING INFORMATION

Pre-Heat

This function operates automatically in conjunction with the Timers. When a Timer is selected, the heater may operate anywhere within an hour prior to the programmed starting time on the Timer.

This function is called Pre-heat since it ensures the room reaches the desired temperature by the time the Timer programs ON time. The room temperature is sensed one hour before reaching Timers programmed ON time.

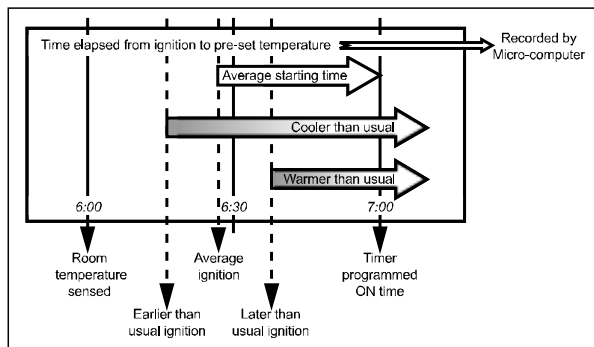

The temperature differential at the time of sensing the room temperature combined with the data from previous operation governs exactly how long before the programmed 'ON' time the micro-computer will operate the heater and ignite the burner.

Humidifier Tray

Your heater is fitted with an enamelled tray behind the air outlet so that you can humidify the air. To fill the tray, open the access panel as shown in the diagram and pour water into the tray using the spout built into the access panel. Do not fill the tray over 3/4 full.



The air will be humidified as it passes over the water in the tray.

Humidifier Tray may become hot!

DO NOT FILL THE HUMIDIFIER TRAY WHILST THE HEATER IS IN OPERATION.

DO NOT fill the humidifier tray for at least 5 minutes after the heater stops operating.

DO NOT operate the heater without the humidifier tray in place.

If you notice water in the humidifier tray, but have not placed any there do not be alarmed, this is normal. Due to the high efficiency of Energysaver® heaters, water in the form of condensate is accumulated in the flue system which drains into the humidifier tray.

If the humidifier is in use, it will need filling approximately about once a day during the heating season.

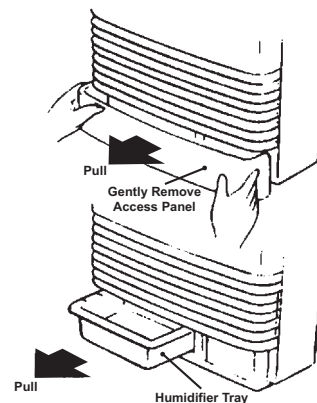

Vertical Louvre Adjustment

The warm air flow direction may be altered by carefully inserting a screwdriver or similar tool and gently bending the vertical louvre(s) either to the left or the right.

NOTE: These louvres are not designed to be adjusted more than 6 times.

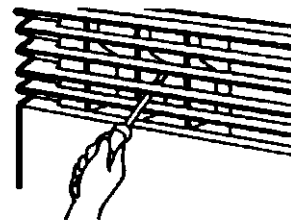

Outside Flue Terminal

On cold days steam may be discharged from the flue terminal. This is normal with high efficiency appliances such as the Energysaver® range and does not indicate any fault.

CARE OF YOUR ENERGYSAVER®

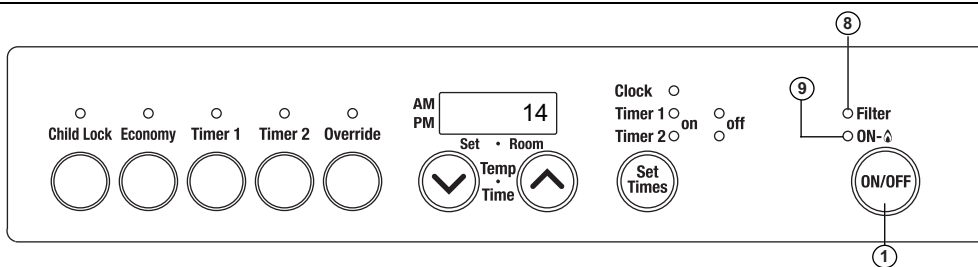

Cleaning

Your heater requires very little maintenance, but the following information will help you to keep it looking like new and working efficiently.

- Unplug electrical cord before cleaning.
- All parts of the heater can be cleaned using a soft, damp cloth and a mild detergent.
- **DO NOT** use solvents or abrasives to clean any parts.

Care for the Humidifier Tray: if the humidifier tray gets dirty, wash in warm soapy water.

How to clean: when heater is cold, remove the lower cover panel and pull out the humidifier tray from appliance. Ensure there is no water in the tray. If there is water in the tray, Keep the tray level to avoid spilling then wash in warm soapy water.

Fan Filter

To protect the appliance internals from dust particles or lint, a filter is situated at the rear of the heater.

If the filter becomes blocked, the filter indicator ⑧ will flash to indicate that it should be cleaned. Clean the filter weekly during the heating season. Dusty or clogged filters reduce the air flow through the appliance reducing heating effectiveness.

- **DO NOT remove filter when appliance is operating.**
- If the filter requires cleaning, clean filter whilst the appliance is not operating.

The 'ON' indicator ⑨ will flash & the display shows error code 14.

Note: If you do not clean the filter at regular intervals and the Filter Indicator ⑧ is allowed to remain flashing, then the appliance will stop. You must clean the filter before operating the heater again.

- **DO NOT** use the heater with the filter indicator flashing as this may cause overheating.
- **DO NOT** wait for the filter indicator to flash before cleaning filters, how to clean the Fan Filter: Dust: Use duster or vacuum to remove dust. Oil: Wash the fan filter with a mild detergent. Drain off the water and dry the filter.

Remove filter by pulling straight up and out from appliance.

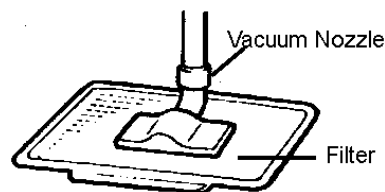
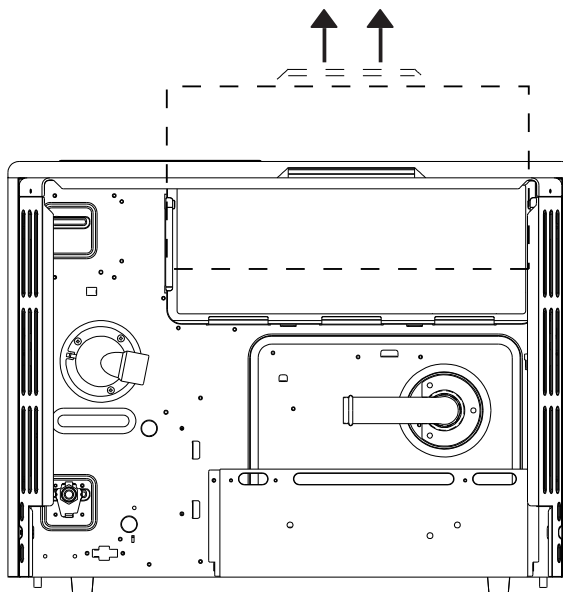

Ensure to fit the Fan Filter back in the appliance after cleaning. DO NOT operate appliance without filter in place.

Regularly check the outside flue terminal to make sure it is clear from plant growth and from other obstructions. Refer "SAFETY" on page 2 for additional requirements.

SAFETY DEVICES

Overheat Switch:

This device automatically shuts the gas supply off if the heater exceeds a predetermined temperature.

This is normally caused by an obstruction in front of the louvres, or a blocked fan filter.

If the overheat switch operates, turn the unit 'OFF', remove the obstruction (clean filters) and allow the unit cool off for 10-15 minutes before re-operating.

Fusible Links:

The fusible link activates under conditions of severe overheating and shuts off the gas supply.

A service call will be required to repair the appliance.

Flame Failure Device:

If the flame goes out during operation this device shuts off gas to the burner. To reset, turn the unit 'OFF', then 'ON' again. If this happens repeatedly a service call is required.

Electrical Fuse:

The electrical circuits are protected by an electric fuse. When the fuse blows, the heater will not operate. The fuse must be replaced by an authorised person.

Power Failure:

In the event of a power failure or power cut, the gas valves will automatically close. After the power is re-instated the appliance will automatically re-start. The time of day will need to be reset to the correct current time (refer "SETTING THE CLOCK" on page 10).

SERVICE

Rinnai Australia has a service and spare parts network in all states. Our service network personnel are fully trained and equipped to give the best service on your Rinnai appliance. If your appliance needs servicing, please ring one of the service contact numbers on the back of this booklet.

Rinnai recommends that this appliance is serviced every 2 years.

INSTALLATION MANUAL - TABLE OF CONTENTS

SPECIFICATIONS	17
Specification Table	17
DIMENSIONS	18
HEATER LOCATION	20
Location.....	20
Gas supply	20
Purging the gas supply	20
Electrical supply	20
FLUE INSTALLATION CONFIGURATIONS	21
FLUE POSITIONING	22
Flue terminal location	22
HEATER INSTALLATION	23
COMMISSIONING	24
TROUBLE SHOOTING	25
Trouble Shooting Check List	25
ERROR MESSAGES	27
WIRING DIAGRAM	28
CONTACTS	29

SPECIFICATIONS

Specification Table

General

	RHFE-309FT	RHFE-559FT
Dimensions	695mmH x 257mmD x 465mmW	582mmH x 257mmD x 760mmW
Weight	21 kg	26 kg
Gas Control valve	Rinnai® Electronic Modulating Gas Control Valve	
Burner	Fabricated Stainless Steel – Bunsen Burner Type	
Gas Inlet thread	R1/2 Male (15mm)	
Flue System	Fan assisted, twin chamber co-axial flue system, provides air for combustion to the appliance and allows expulsion of combustion products to atmosphere. Results in 'room sealed' appliance.	
Ignition	Direct continuous spark electronic ignition – no pilot.	
Electrical supply	240V 50Hz with supply lead and 3 pin plug. Replace with Rinnai® genuine part.	
Standby power consumption	<1W	
Convection fan	Centrifugal Drum Type Fan	Cross Flow Fan
Temperature range	16°C - 26°C x 1°C Increments	
The manufacturer reserves the right to change or modify specifications without notice.		

NOTE: For other appliance Specifications refer to appliance data plate.

DIMENSIONS

RHFE-309FT

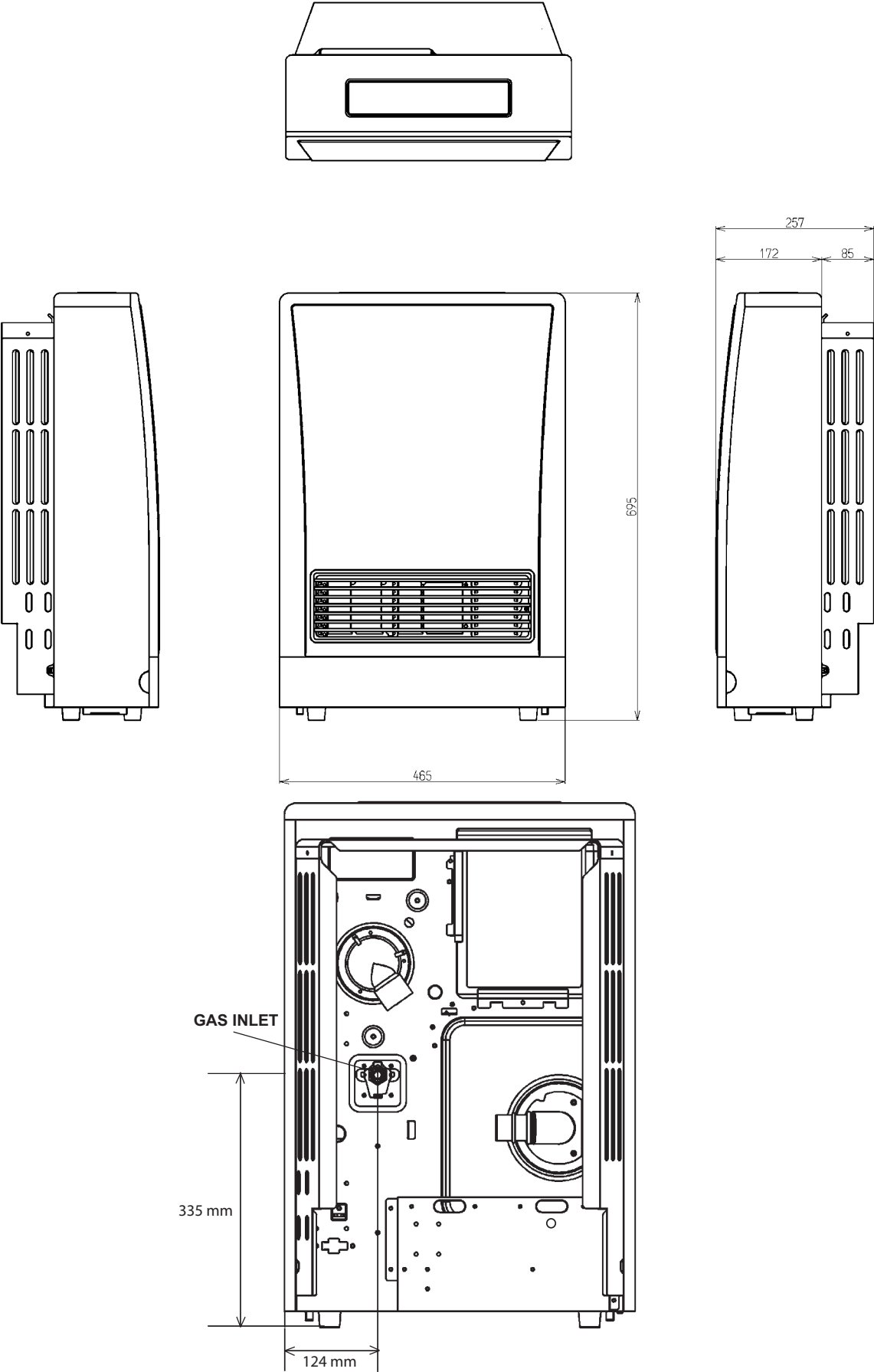

DIMENSIONS

RHFE-559FT

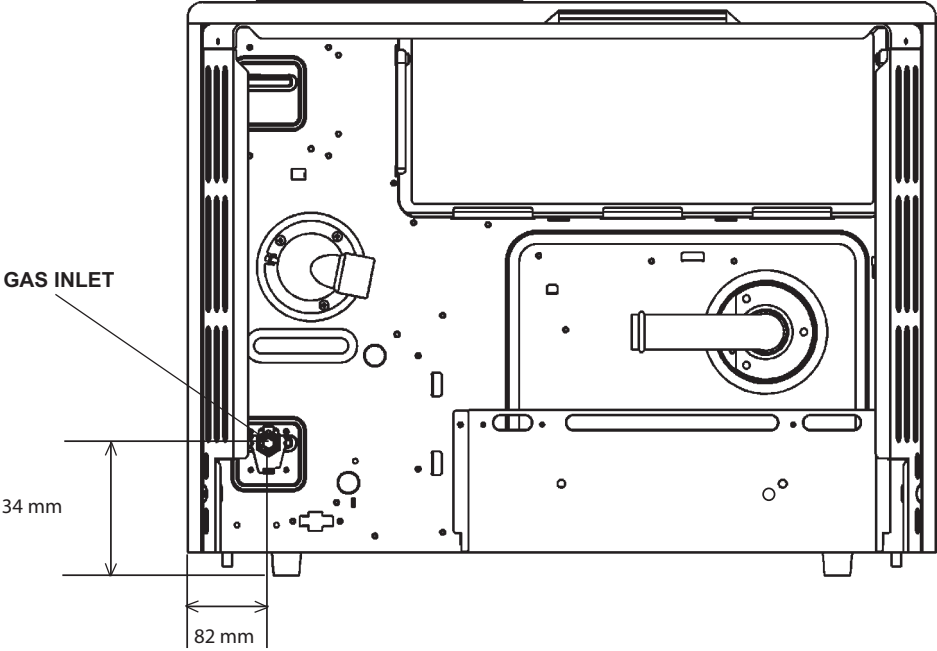
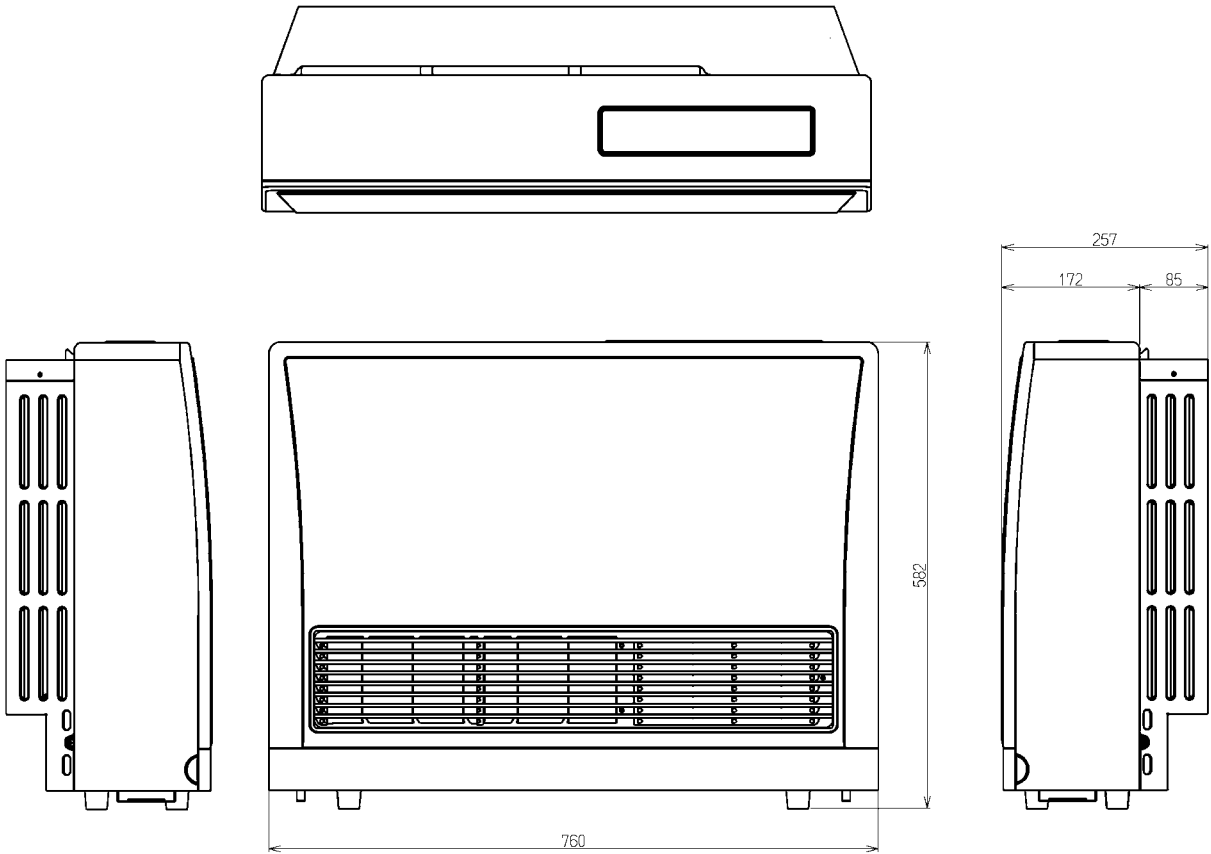

HEATER LOCATION

Location

When positioning the heater the main variables governing the location are Flueing and Warm Air Distribution.

This heater must not be installed where curtains or other combustible materials could come into contact with it. In some cases curtains may need restraining. Refer to page 2 for additional safety consideration.



For all installations, ONLY Rinnai Energysaver® Flue components MUST be used. The Rinnai Energysaver® MUST NOT be flued into 'natural draft' flue system or via a chimney.

Consult the Rinnai 'Energysaver® Space Heater Co-Axial flue System installation' manual included with the 'On Wall' or 'Direct' flue kits for detailed flue installation instructions.

Gas Supply

The gas supply terminates outside the heater at the rear of the appliance.

Locate the gas supply pipe to suit position as per the heater gas inlet. Refer to the drawings on page 18 and page 19 for appliance gas inlet location.

Gap required between the wall and heater body is 85 mm to 200 mm depending on Back Cover set used.



Gas pipe sizing must consider the gas input to this appliance as well as all other gas appliances in the premises. The gas meter and regulator must be specified for the total gas rate. Suitable sizing chart such as the one in AS 5601 should be used.

Purging the gas supply

All foreign materials such as filings must be purged from the gas supply, as they may cause the gas control valve to malfunction.

Electrical Supply

This heater has a power cord with a three pin plug supplied. The cord passes out of the rear of the appliance and can extend to the left or right of the appliance.

A dedicated 240 V earthed 10 Amp power point must be used with this appliance. The power point must to the left or the right side, it **must not** be above the heater. Alternatively the appliance can be direct wired if the power supply is to be concealed.



Consult a qualified electrician if direct wiring is required as it must comply with the requirements of AS5601 and AS3000 and any other relevant local regulations.

FLUE INSTALLATION CONFIGURATIONS



Consult the 'Energysaver® Space Heater Co-Axial Flue Systems Installation Manual' included with the 'On Wall' or 'Direct' flue kits for detailed flue installation instructions. Use only Rinnai Flue components with this appliance.

The following configurations are currently available. For alternative configurations contact Rinnai

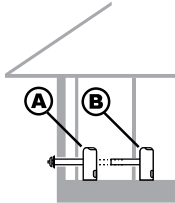
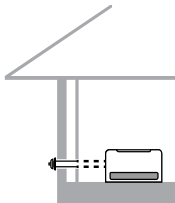
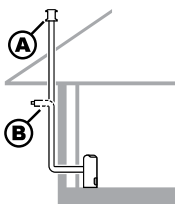
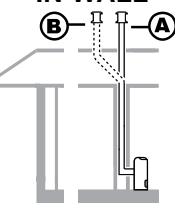
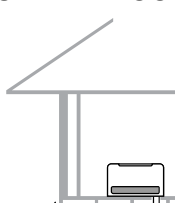
DIRECT / EXTENDED 	Components			
	Option A (Direct)		Option B (Direct Extended)	
	Direct Flue Kit	ESDFK	Direct Flue Kit Co-Ax Pipe 900mm (Optional) #	ESDFK ESPIPE900
SIDEWAYS 	Components			
	Direct Flue Kit Co-Ax Pipe 900mm # Back Cover Set (see note below)	ESDFK ESPIPE900		
EXTERNAL WALL 	Components			
	Option A (Vertical Termination)		Option B (On Wall Termination)	
	Direct Flue Kit Co-Ax Pipe 900mm # Bend (2 x 45°) Condensate Trap Roof Cowl	ESDFK ESPIPE900 ESBEND ESCONDK ESROOFCOWL	Direct Flue Kit Co-Ax Pipe 900mm # Bend (2 x 45°) Condensate Trap	ESDFK ESPIPE900 ESBEND ESCONDK
IN-WALL 	Components			
	Option A (Direct)		Option B (Offset)	
	Vertical Adaptor Kit § Co-Ax Pipe 900mm # Roof Cowl	ESFKITIW ESPIPE900 ESROOFCOWL	Vertical Adaptor Kit § Co-Ax Pipe 900mm # Bend (2 x 45°) Roof Cowl	ESFKITIW ESPIPE900 ESBEND ESROOFCOWL
UNDER FLOOR 	Components			
	Direct Flue Kit Co-Ax Pipe 900mm # Bend (2 x 45°) Back Cover Set (see note below)	ESDFK ESPIPE900 ESBEND		

Order lengths as required § Includes Condensate Trap (ESCONDK)



The Energysaver Heater comes supplied with a standard back cover set. For 'Sideways' & 'Underfloor' installations, refer to the 'Energysaver Space Heater Co-Axial Flue System Installation Manual' for the alternative back cover set required.



Flue is NOT to be terminated under the floor or in a roof space. 'Down & Out' and vertical 'through roof' flue installations are permitted ONLY when the flue terminal is located externally.



For horizontal installations there must be a continuous fall of at least 2° to the termination point to drain condensate.

All terminations exceeding a vertical height of 1.5 metres must incorporate a condensate trap.

'Down & Out' Flue systems must have a continuous fall of at least 2° to the termination point to drain condensate. Flue terminal must be at least 300 mm above the ground in accordance with AS 5601, Clause 5.13.6.2 and Fig. 5.3.

FLUE POSITIONING

Flue Terminal Location



The flue terminal should be positioned away from flammable materials.

Ensure that the location of the flue terminal can comply with the requirements of AS 5601 2004 Clause 5.13.6.2 and Fig. 5.3 which is reproduced below.

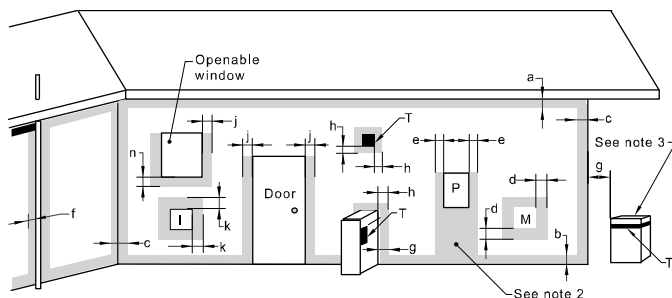

LEGEND:
 T = Flue terminal
 I = Mechanical air inlet
 M = Gas meter
 P = Electricity meter or fuse box
 Shading indicates prohibited areas for flue terminals

Ref.	Item	Minimum clearances (mm)	
		Natural draft	Fan assisted
a	Below eaves, balconies and other projections: • Appliances up to 50 MJ/h input • Appliances over 50 MJ/h input	300 500	200 300
b	From the ground, above a balcony or other surface †	300	300
c	From a return wall or external corner †	500	300
d	From a gas meter (M) (see 4.7.11 for vent terminal location of regulator)	1000	1000
e	From an electricity meter or fuse box (P)	500	500
f	From a drain pipe or soil pipe	150	75
g	Horizontally from any building structure † or obstruction facing a terminal	500	500
h	From any other flue terminal, cowl, or combustion air intake †	500	300
j	Horizontally from an openable window, door, non-mechanical air inlet, or any other opening into a building with the exception of sub-floor ventilation: • Appliances up to 150 MJ/h input • Appliances over 150 MJ/h input up to 200 MJ/h input • Appliances over 200 MJ/h input up to 250 MJ/h input † • Appliances over 250 MJ/h input † • All fan-assisted flue appliances, in the direction of discharge	500 1500 1500 1500 -	300 300 500 1500 1500
k	From a mechanical air inlet, including a spa blower	1500	1000
n	Vertically below an openable window, non-mechanical air inlet, or any other opening into a building with the exception of sub-floor ventilation: • Space heaters up to 50 MJ/h input • Other appliances up to 50 MJ/h input • Appliances over 50 MJ/h input and up to 150 MJ/h input • Appliances over 150 MJ/h input	150 500 1000 1500	150 500 1000 1500

† Unless appliance is certified for closer installation

All distances are measured to the nearest part of the terminal.

Prohibited area below electricity meter or fuse box extends to ground level.

See Clause 5.13.6.6 for restrictions on a flue terminal under a covered area.

See Appendix J, Figures J2(a) and J3(a), for clearances required from a flue terminal to an LP Gas cylinder. A flue terminal is considered to be a source of ignition.

For appliances not addressed above acceptance should be obtained from the technical regulator

FIGURE 5.3 (in part) MINIMUM CLEARANCES REQUIRED FOR BALANCED FLUE TERMINALS, FAN-ASSISTED FLUE TERMINALS, ROOM-SEALED APPLIANCE TERMINALS OR THE TERMINALS OF OUTDOOR APPLIANCES

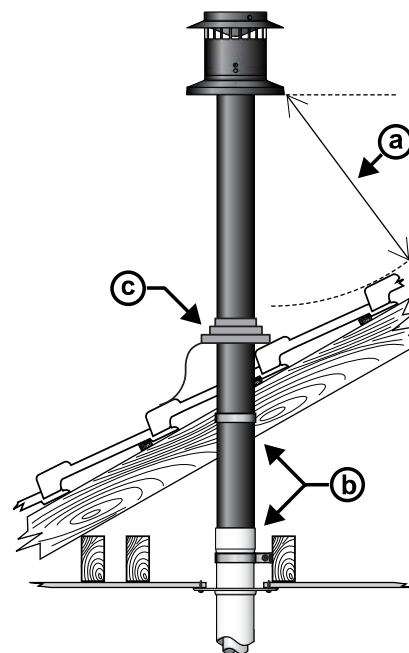

- (a)** Minimum clearance 500 mm to nearest part of roof.
- (b)** Minimum clearance 25mm to combustibles.
- (c)** Decktile or lead collar flashing.



*** AS 5601 : 2004 was current at the time of printing this manual, but may have been superseded. It is the installers responsibility to ensure that the current version of this standard is used.**

HEATER INSTALLATION

1. UNPACKING THE APPLIANCE

The heater is supplied in one carton containing; Heater, Standard Rear Cover Set and Bolt Pack.

Remove all packaging materials. Check for damage. If **any** damage is evident **DO NOT** install or operate this appliance. Contact your supplier for advice. Before installing the heater, check it is labelled for the correct gas type, (refer to the data label at the rear of the heater). Refer to the local gas authority for confirmation of gas type if you are in doubt.



The heater does not come supplied with flue components. These are purchased separately.

ONLY Rinnai Energysaver® Co-Axial Flue System Flue components can be used with this appliance.



240 VOLTS, RISK OF ELECTRICAL SHOCK!

Ensure the appliance is disconnected from mains power.

2. CONNECTING THE APPLIANCE TO THE CONSUMER GAS PIPE

1. Remove the plastic protection cap from the threaded gas inlet located at the rear of the appliance.
2. Position the appliance gas inlet in line with gas supply from wall.
3. Attach gas supply pipe to the appliance gas inlet and tighten - finger tight. Appliance has R1/2 fitting.
4. On the wall behind the appliance, at a level of about midway of the heaters height, mark the vertical centre line of the heater.
5. Mark the flue penetration position in accordance with 'Energysaver® Space Heater Co-Axial Flue System Installation' manual.
6. Undo the gas connection, remove the heater.
7. Cut Flue penetration(s)
8. Mark out the securing bracket screw holes in accordance with the drawing adjacent and table below using the centre line as reference.

Model	A	B
RHFE-309FT	250 mm	624 mm
RHFE-559FT	350 mm	537 mm

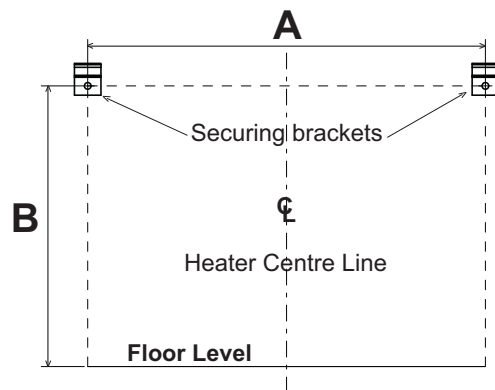

9. Attach the two securing brackets supplied to the wall using the two 8g x 30mm screws supplied, or suitable equivalent.

SECURING BRACKET

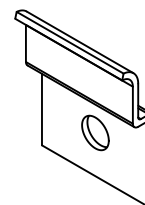

10. Install flue system in accordance with 'Energysaver® Space Heater Co-Axial Flue System Installation manual'.
11. Return the heater to the final position.
12. Connect flue in accordance with 'Energysaver® Space Heater, Co-Axial Flue System Installation Manual'.
13. Connect gas supply line and fully tighten connection.

HEATER INSTALLATION



Use a soapy solution to test all gas connections. If a leak is present bubbles will form at the leak point. When finished remove any residue with a rag. Prevent any soapy solution from coming in contact with electrical components.

14. Fit left and right cover panels to the rear of the appliance by clipping the panels onto the location tabs then fastening into position using the two 6g x 8mm pan head screws supplied. Screws locate into pre-drilled and formed recesses at the bottom edge of the panels
15. Remove the Fan Filter and carefully fit the top cover panel ensuring the rear fold locates neatly between the two securing brackets and wall.
16. Secure the top cover panel with two 6g x 8mm pan head screws supplied or suitable equivalent.
17. Replace the Fan Filter.



Air hose and heater exhaust connections at the Energysaver® heater MUST be made and check in accordance with these instructions. Improper connections may result in dangerous situations, for example, the dispersion of combustion products in the space being heated.

COMMISSIONING

For Commissioning Instructions, refer to the Commission sheet attached behind the front panel of the appliance.

TROUBLE SHOOTING

Trouble Shooting Check List

Please check this list before asking for Service

Fault	No Power ON/Combustion Indicator	Burner doesn't ignite	Unusual Combustion	Combustion stops during operation	Smell of Gas	Noisy Ignition	Remedy
Not plugged in	●	●					Plug in power cord and press the control panel 'ON' / 'OFF' button.
Power Cut	●	●		●			Re-ignite manually after power is restored.
(Initial Installation) Air in gas pipe		●					Purge air (Installer).
Gas Filter Blocked		●	●				Service Call (Contact Rinnai).
Mis-ignition	●	●					Check customer instructions.
Flue Terminal obstructed			●	●		●	Clear obstruction.
Flue manifold not connected					●	●	Service Call (Contact Rinnai).
Louvre obstructed				●			Clear obstruction.
Air Filter Blocked				●			Clean filter (weekly).
Gas Escape					●		Service Call (Contact Rinnai).
'ON' Timer is set		●					Cancel 'ON' Timer or press the override button.
Gas turned 'OFF' at meter		●					Turn Gas 'ON'.
Function / Child Lock Set		●					Cancel Function / Child Lock.

If you are unsure about the way the unit is operating, contact Rinnai or your Agent.

TROUBLE SHOOTING

Before asking for a service call please check the following.

These symptoms are part of the normal operation of the unit and do not indicate a fault.

Symptom		Explanation
At Ignition:		
Warm air does not start when the burner lights.	→	The fan is started automatically after a short delay. This is to allow the heat exchanger to warm up, helping to avoid cold draughts.
Smoke or strange smells are produced on the first trial light up after installation.	→	This is caused by grease or oil from the manufacturing process on the heat exchanger and dust, and will stop after a short time.
Sharp clicking noises at ignition, or when the unit cuts down on the thermostat, or goes out.	→	This is simply expansion noise from the metal heat exchanger.
During combustion:		
Clunking noise when the thermostat operates.	→	This is the sound of the solenoid gas valves opening and closing.
When the unit is turned 'OFF':		
Convection fan continues to run after turning 'OFF'	→	This is to remove the residual heat from the heat exchanger. The fan will stop when the unit cools down.
Other points:		
Steam is discharged from the flue terminal.	→	High efficiency appliances tend to discharge water vapour on cold days. This is normal.
Heater does not start even when 'ON' button is pushed and thermostat is on HIGH.	→	Check timer. Timer must be in the "OFF" position for manual operation. Room temperature is hotter than 'High' setting.
Timers:		
Timers do not operate at set time.	→	Timers may either be inactivated or incorrectly programmed. Repeat programming. Refer to "OPERATING THE TIMERS" on page 11.
Timer operates for 30 seconds then cuts out.	→	Room temperature may be higher than set temperature. Adjust temperature upwards if desired.

ERROR MESSAGES

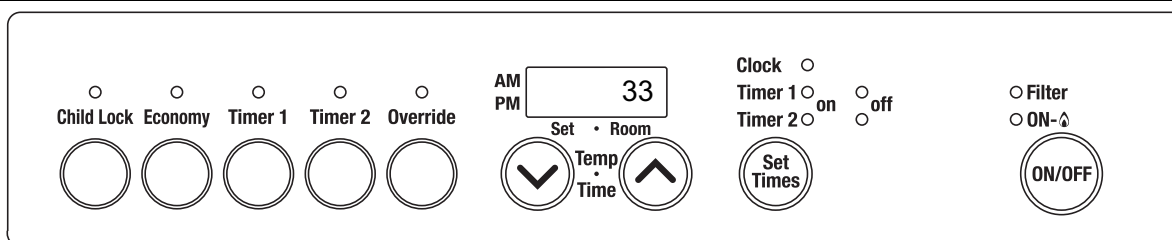

The Energysaver® Range of heaters has the ability to monitor its own operation continuously. If a fault occurs, an Error Message will flash on the Digital Display (11) on the control panel. This assists with diagnosing the fault, and may enable you to overcome a problem without a service call. Please quote the code displayed when inquiring about service.

Code Displayed	Fault	Remedy
11	Ignition failure	Check gas supply is turned 'ON' Turn Heater 'OFF' then 'ON' again Service call if repeated
12	Flame failure	Check gas is turned 'ON'
14	Overheat	Clean filter Service call if repeated
16	Room Overheat	Lower room temperature to less than 40°C
31 32	Room temperature sensor faulty	Service call
33 34	Overheat temperature sensor faulty	Service call
53	Sparker failure	Service call
61	Combustion fan failure	Service call
62	Convection fan failure	Service call
70	Faulty 'ON'/'OFF' Switch	Service call
71	Faulty solenoids	Service call
72	Faulty Flame Rod	Service call
73	Communication error	Service call

In all cases, you may be able to clear the Error Message simply by turning the heater 'OFF', then 'ON' again. If the Error Message still remains or returns on the next operation, contact Rinnai or your nearest service agent and arrange for a service call.



Service calls for general cleaning, maintenance and wear and tear are not necessarily covered under the warranty. Service calls of this nature may be chargeable.
Faults caused by insufficient gas supply, gas quality, installation errors or operation errors are not covered by the Rinnai warranty. Refer to the Warranty Card for details.

WIRING DIAGRAM

RHFE-309FT/RHFE-559FT

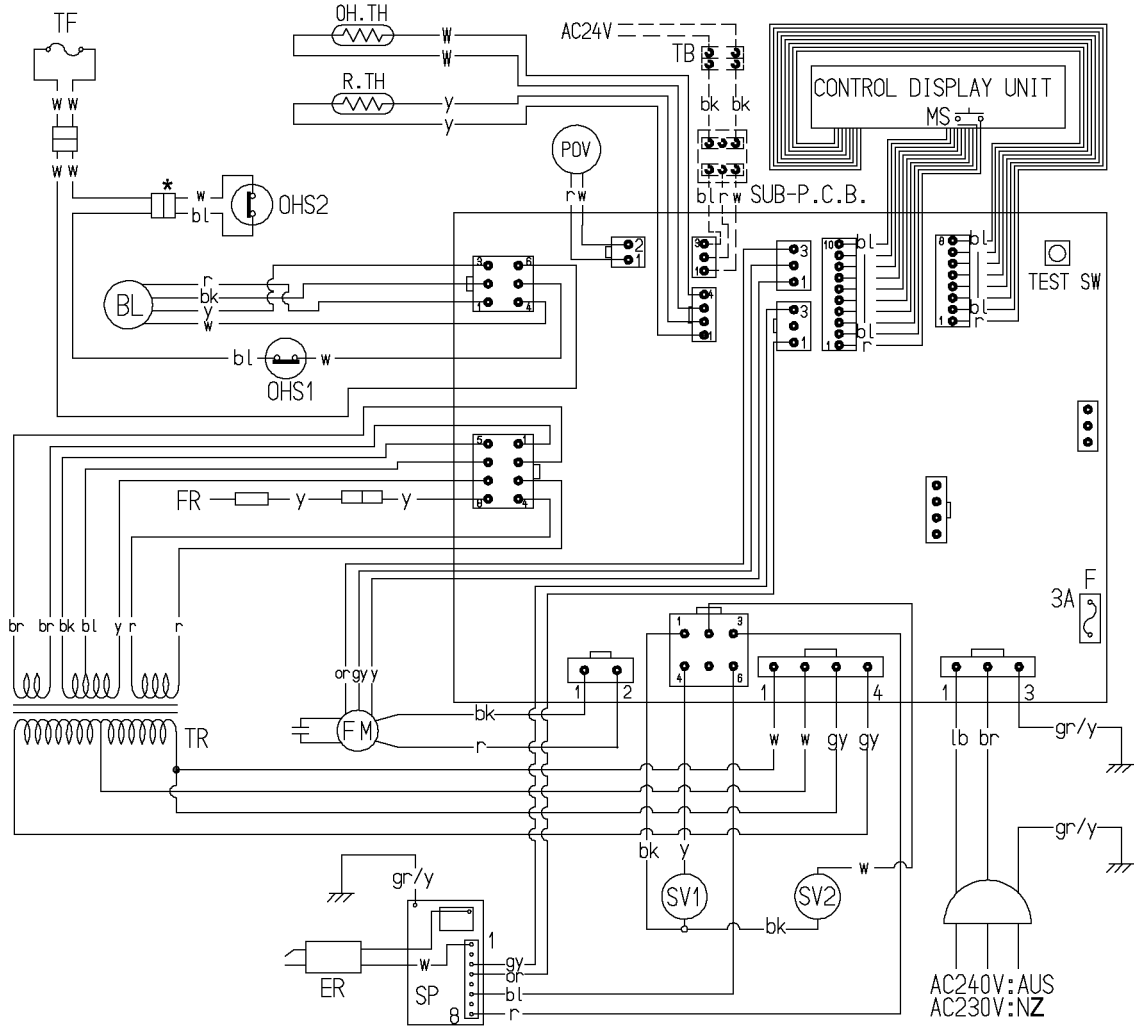

CODE	COLOUR	CODE	COLOUR
bk	black	w	white
bl	blue	y	yellow
lb	light blue	gy	gray
gr/y	green/yellow	or	orange
r	red	br	brown

MARK	PARTS NAME
MS	MAIN SWITCH
R.TH	THERMISTOR
TF	THERMAL FUSE
F	FUSE
ER	ELECTRODE
POV	MODULATING SOLENOID VALVE
TR	TRANSFORMER
FR	FLAME ROD
CF	CONVECTION FAN
FM	CONVECTION FAN MOTOR
SP	SPARKER
OH.TH	OVER HEAT THERMISTOR
SV1~2	SOLENOID VALVE 1~2
BL	COMBUSTION FAN MOTOR
FCC	FAN CONTROL CIRCUIT
CPU	CENTRAL PROCESSING UNIT
MB	MAIN BURNER
OHS.1~2	OVERHEAT SWITCH 1~2
TB	TERMINAL BLOCK

* NOTE: THIS CONNECTOR APPLICABLE TO RHFE-559FT ONLY.

Rinnai

Rinnai Australia Pty. Ltd. ABN 74 005 138 769

Head Office

10-11 Walker Street,
Braeside, Victoria 3195
P.O. Box 460
Tel: (03) 9271 6625
Fax: (03) 9271 6622

Rinnai has a Service and Spare Parts network with personnel who are fully trained and equipped to give the best service on your Rinnai appliance. If your appliance requires service, please call our Helpline. Rinnai recommends that this appliance be serviced every 2 years.

Internet: www.rinnai.com.au E-mail: enquiry@rinnai.com.au

National Help Line

Sales & Service
Tel: 1300 555 545* Fax: 1300 555 665*

**Cost of a local call Higher from mobile or public phones.*



102808



RHF559-1152(00)