

***Owners Guide
and
Installation Instructions***

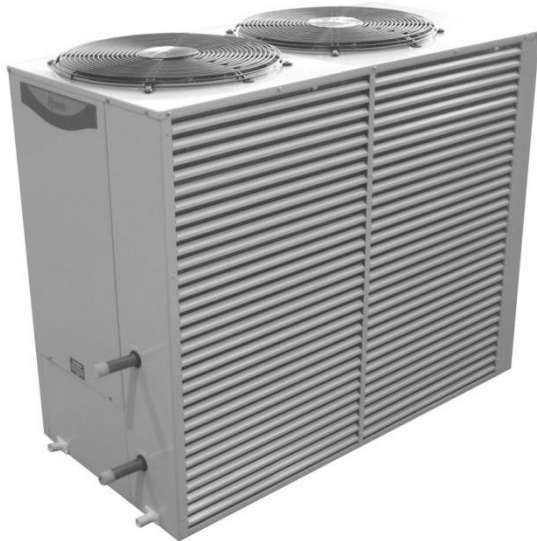

***Commercial Air Sourced Heat Pump
Water Heater***



Install a Rheem

*This water heater must be installed and serviced by an qualified person.
Please leave this guide with a responsible officer.*

**Notice to Victorian Customers from the
Victorian Plumbing Industry Commission.**

**This water heater must be installed by a licensed person as required by
the Victorian Building Act 1993.**

Only a licensed person will give you a Compliance Certificate, showing that the work complies with all the relevant standards. Only a licensed person will have insurance protecting their workmanship for 6 years. Make sure you use a licensed person to install this water heater and ask for your Compliance Certificate.

PATENTS

This water heater may be protected by one or more patents or registered designs.

© Registered trademark of Rheem Australia Pty Ltd.
™ Trademark of Rheem Australia Pty Ltd.

CONTENTS

RESPONSIBLE OFFICER – We recommend you read pages 4 to 16.
The other pages are intended for the installer but may be of interest.

Contents	3
About Your Water Heater	4
How Your Water Heater Works.....	8
Regular Care	10
Water Supplies.....	12
Save A Service Call	14
Installation.....	17
Heat Pump And Tank Assembly	29
Connections – Plumbing	32
Connections – Electrical.....	34
Manifold Installations.....	39
Commissioning.....	42
Draining The Water Heater	43
Automatic Defrost	45
Rheem Heat Pump Water Heater Warranty - Australia Only	-46

ABOUT YOUR WATER HEATER

WATER HEATER APPLICATION

This water heater is designed for the purpose of heating potable water. Its use in an application other than this may shorten its life.

MODEL TYPE

Congratulations for choosing a Rheem® commercial heat pump water heater. The Rheem air sourced heat pump water heater is designed for outdoor (non ducted) or indoor installation (ducted or non ducted) depending on the model.

HOW HOT SHOULD THE WATER BE?

The heat pump (compressor, evaporator and fan) will operate until a water temperature of approximately 60°C is reached. During periods of ambient air temperature below 7°C, the water temperature is boosted automatically, if required, by an auxiliary booster heater, if installed.

To meet the requirements of the National Plumbing Standard (AS/NZS3500.4) the temperature of the stored water must not be below 60°C.

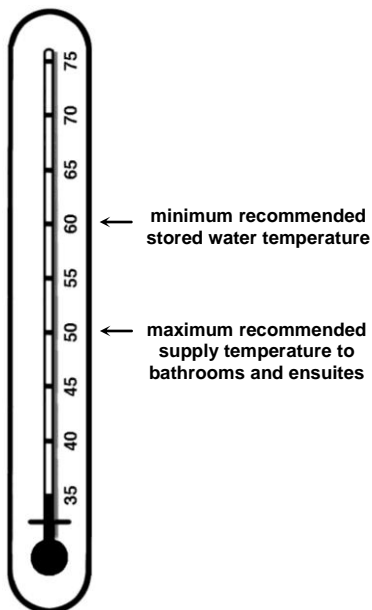

HOTTER WATER INCREASES THE RISK OF SCALD INJURY

This water heater can deliver water at temperatures which can cause scalding. Check the water temperature before use, such as when entering a shower or filling a bath or basin, to ensure it is suitable for the application and will not cause scald injury.

We recommend and it may also be required by regulations that an approved temperature limiting device be fitted into the hot water pipe work to the bathroom and ensuite when this water heater is installed. This will keep the water temperature below 50°C at the bathroom and ensuite. The risk of scald injury will be reduced and still allow hotter water to the kitchen and laundry.

TEMPERATURE ADJUSTMENT

To adjust temperature settings, refer to the instructions printed on the back of the wall controller cover for full instructions and on [page 45](#) for defrost mode specific instructions.

ABOUT YOUR WATER HEATER

WARNING

This water heater is only intended to be operated by persons who have the experience or the knowledge and the capabilities to do so. This water heater is not intended to be operated by persons with reduced physical, sensory or mental capabilities i.e. the infirm, or by children. Children should be supervised to ensure they do not interfere with the water heater.

This water heater uses 415V / 240 V AC electrical power for operation of the control systems and other electrically operated components. The removal of the access cover(s) will expose 415V / 240 V wiring. They must only be removed by a qualified person.

- Do not use **aerosols, stain removers and chemicals** near the water heater whilst it is working. Gases from some aerosol sprays, stain removers and chemicals are corrosive to the materials used in the heat pump system.
- Do not store swimming pool chemicals, household or industrial cleaners, etc., near the water heater.
- Ensure the air inlet and outlet louvres and air flow are not obstructed in any way at any time.

SAFETY

This water heater is supplied with an over-temperature energy cut-out. A separate controller is supplied with a thermostat. Additionally the storage tanks are supplied with a combination temperature pressure relief valve. These devices must not be tampered with or removed. The water heater must not be operated unless each of these devices is fitted and is in working order.

If the electrical supply conduit to the water heater is damaged, it must be replaced by a qualified person in order to avoid a hazard. Phone your nearest Rheem Service Department or Accredited Service Agent to arrange for an inspection.

 **Warning:** For continued safety of this water heater it must be installed, operated and maintained in accordance with the Owner's Guide and Installation Instructions.

The Rheem warranty may not cover faults if relief valves or other safety devices are tampered with or if the installation is not in accordance with these instructions.

ABOUT YOUR WATER HEATER

TO TURN OFF THE WATER HEATER

- Switch off the electrical supply at the isolating switch to the water heater and the controller.
- Close the cold water isolation valve at the inlet to the water heater.

TO TURN ON THE WATER HEATER

- First, ensure the water is connected to storage tanks, the system is filled with water and all valves between the tanks and the water heater are open
- Open the cold water isolation valve fully on the cold water line to the water heater.
- Switch on the electrical supply at the isolating switch to the water heater and the controller.

Note: The water heater may not turn on immediately when it is first switched on, if it is switched on within 20 minutes of it having been switched off at the isolating switch, or the heat pump has just completed a heating cycle. The water heater will wait until the conditions for start up are favourable in order to protect the compressor from damage. This may take up to 20 minutes. The auxiliary booster will operate instead of the heat pump if the ambient air temperature is less than 5°C.

HOW DO I KNOW IF THE WATER HEATER IS INSTALLED CORRECTLY?

Installation requirements are [shown on page 18 to 24](#). The water heater must be installed:

- by a qualified person, and
- in accordance with the installation instructions, and
- in compliance with Standards AS/NZS 3500.4, AS/NZS 3000 and all local codes and regulatory authority requirements.

In New Zealand, the installation must also conform with Clause G12 of the New Zealand Building Code.

DOES THE WATER CHEMISTRY AFFECT THE WATER HEATER?

The water heater is suitable for most public water supplies, however some water chemistries may have detrimental effects on the water heater, its components and fittings. Refer to [“Water Supplies” on page 12](#). If you are not sure, have your water chemistry checked against the conditions [described on pages 12 to 13](#).

ABOUT YOUR WATER HEATER

HOW LONG WILL THE WATER HEATER LAST?

Your water heater is supported by a manufacturer's warranty (refer to page 10). There are a number of factors that will affect the length of service the water heater will provide. These include but are not limited to the water chemistry, the water pressure, temperature (inlet and outlet) and the water usage pattern. Refer to "Precautions" on page 7.

PRECAUTIONS

Where damage to property can occur in the event of the water heater leaking, the water heater must be installed in a safe tray. Construction, installation and draining of a safe tray must comply with AS/NZS 3500.4 and all local codes and regulatory authority requirements.

The water heater must be maintained in accordance with the Owner's Guide and Installation Instructions. Refer to "Regular Care" on page 10.

If this water heater is to be used where an uninterrupted hot water supply is necessary for your application, or business you should ensure that you have back up redundancy within the hot water system design. This should ensure the continuity of hot water supply in the event that this water heater were to become inoperable for any reason. We recommend you seek advice from your plumber or specifier about your needs and building back up redundancy into your hot water supply system.

ENVIRONMENT

At the end of the service life of the heat pump water heater and prior to the water heater being disposed of, a person qualified to work with refrigerants must recover the refrigerant from within the sealed system. The refrigerant must not be vented to atmosphere. Phone your nearest Rheem Service Department or Accredited Service Agent to arrange for an inspection.

HOW YOUR WATER HEATER WORKS

The Rheem commercial heat pump water heater is an instantaneous type and does not have an integral storage cylinder. The unit is designed to be installed indoors or outdoors, depending on the model. The water heater's evaporator absorbs heat from the surrounding air and transfers this heat into the water. A circulator transfers the heated water to a bank of storage tanks. The heat pump produces a sound level of up to 61 dBA on the outdoor model and 70 dBA on the indoor model (measured at 3 metres) when they are operating. The principal of operation and sound level are similar to that of an air conditioner.

When hot water is drawn off and cold water enters the storage tanks, a remote thermostat activates the fan, compressor and circulating pump of the water heater. Air is drawn in through the inlet louvres on the side of the water heater and then past the evaporator, where heat is transferred from the air to a refrigerant fluid. The fluid is compressed and passes to the condenser (heat exchanger) where heat is transferred into the water. The pump circulates water from the bottom of the storage tanks through the heat exchanger and the heated water is circulated back into the storage tanks. The fan discharges the cooled air through the fan grilles on the top of the water heater. This process continues until the water in the storage tanks reaches a temperature of 60°C.

Even on cold days, heat is drawn from the surrounding air. The heat pump will operate most efficiently at temperatures between a minimum of 5°C and maximum of 40°C. The efficiency of the water heater is relative to the surrounding air temperature.

Automatic safety controls are fitted to the water heater to provide safe and efficient operation.

OPERATION AT LOW AMBIENT TEMPERATURE

Ice may begin to form on the evaporator when the air temperature falls below 7°C, and this will reduce the heat pump efficiency. The water heating system can be designed to operate in one of two modes when ambient temperature falls below 7°C.

In defrost mode the heat pump will use hot gas injection to melt any ice that may form on the evaporator coil when operating at air temperatures below 7°C.

In auxiliary heating mode the controller deactivates the heat pump and switches to an auxiliary gas or electric water heater. A pump circulates water from the storage tanks through the auxiliary water heater, if installed, until the set temperature of 60°C is reached.

During this period the evaporator will defrost. The auxiliary heater should be set at 60°C.

HOW YOUR WATER HEATER WORKS

MAINS PRESSURE

The water heater is designed to operate at mains pressure by connecting directly to the mains water supply. If the mains supply pressure in your area exceeds that **shown on page 19**, a pressure limiting valve must be fitted. The supply pressure should be greater than 350 kPa for true mains pressure operation to be achieved.

THERMAL CUT OUT

The refrigeration circuit is protected by thermal sensors. These will activate a thermal cut out in the event of excessive heat in the refrigeration system.

If the thermal cut out has activated, the heat pump will not operate for a period of 20 minutes. The water heater will make two more attempts to start up. If the thermal cut out is tripped again after the third attempt, the system will enter lock out and the alarm contacts will close. If connected to a BMS, this will alert the user that the unit is not operating.

The lockout condition can be manually reset by switching the power to the water heater off and then on.

TIMER CONTROL

A timer can be installed in the electrical circuit to the water heater controller to limit the hours of operation of the water heater (e.g. to reduce noise at night). The timer must be weatherproof if it is installed outdoors.

Note: depending on the booster configuration there may be insufficient stored energy available for the next peak period if the system is not up to temperature.

Remember, even on cloudy and cold days your heat pump water heater will heat your stored water.

REGULAR CARE

MINOR SIX MONTH MAINTENANCE

It is recommended minor maintenance be performed every six months by a responsible officer.

The minor maintenance includes:

- Operate the easing lever on the pressure relief valve. It is very important you raise and lower the lever gently. Refer to “Pressure Relief Valve and Expansion Control Valve” on page 11.

 **Warning:** Exercise care to avoid any splashing of water, as water discharged from the drain line will be hot. Stand clear of the drain line's point of discharge when operating the valve's lever.

- Operate the easing lever on the expansion control valve (if fitted). It is very important you raise and lower the lever gently. Refer to “Pressure Relief Valve and Expansion Control Valve” on page 11.

MAJOR FIVE YEAR SERVICE

It is recommended a major five year service be conducted on the water heater. The service must be conducted by a qualified person. Phone Rheem Service or their nearest Accredited Service Agent.

Note: The five year service and routine replacement of any components, such as the anode and relief valve(s), are not included in the Rheem warranty. A charge will be made for this work.

The major service includes:

Replace the pressure relief valve.

Inspect and flush the expansion control valve (if fitted). If required, replace the valve.

Check and inspect the heat pump module for operation.

Visually check the unit for any potential problems.

Inspect all connections.

Note: The water heater may need to be drained during this service. After the completion of the service, the water heater will take some time to reheat the water. Depending upon the power supply connection, hot water may not be available until the next day.

REGULAR CARE

HEAT PUMP SYSTEM

It is recommended the evaporator and refrigeration system is checked every five years. In particularly dusty environments, it may be necessary to have the heat pump system checked and cleaned of dust and residue on a more regular basis.

PRESSURE RELIEF VALVE AND EXPANSION CONTROL VALVE

A pressure relief valve is fitted to the outlet of the heat pump. In many areas, including South Australia, Western Australia and scaling water areas, an expansion control valve is also fitted to the cold water line to the water heater. The expansion control valve may discharge a small quantity of water from its drain line during the heating period instead of the pressure relief valve and temperature pressure relief valve on the storage tanks.

Operate the easing lever on the pressure relief valve and expansion control valve once every six months. **It is very important you raise and lower the lever gently.** The pressure relief and expansion control valve should be replaced at intervals not exceeding 5 years, or more frequently in areas where there is a high incidence of water deposits.

 **Warning:** Exercise care to avoid any splashing of water, as water discharged from the drain line will be hot. Stand clear of the drain line's point of discharge when operating the valve's lever.

 **DANGER:** Failure to do this may result in the water heater heat exchanger failing.

If water does not flow freely from the drain line when the lever is lifted, then the water heater must be checked [Phone Rheem Service](#) or their nearest Accredited Service Agent [to arrange for an inspection](#).

The pressure relief valve should be replaced at intervals not exceeding 5 years, or more frequently in areas where there is a high incidence of water deposits (refer to ["Water Supplies"](#) on page 12)

WATER SUPPLIES

This water heater must be installed in accordance with this advice to be covered by the Rheem warranty.

This water heater is manufactured to suit the water conditions of most public reticulated water supplies. However, there are some known water chemistries which can have detrimental effects on the water heater and its operation and / or life expectancy. If you are unsure of your water chemistry, you may be able to obtain information from your local water supply authority. This water heater should only be connected to a water supply which complies with these guidelines for the Rheem's warranty to apply.

CHANGE OF WATER SUPPLY

The changing or alternating from one water supply to another can have a detrimental effect on the operation and / or life expectation of a number of components in this water heater.

Where there is a changeover from one water supply to another, e.g. a rainwater tank supply, bore water supply, desalinated water supply, public reticulated water supply or water brought in from another supply, then water chemistry information should be sought from the supplier or it should be tested to ensure the water supply meets the requirements given in these guidelines for the Rheem warranty to apply.

SATURATION INDEX

The saturation index (SI) is used as a measure of the water's corrosive or scaling properties.

Where the saturation index is less than -1.0 , the water is very corrosive and the Rheem warranty does not apply to the water heater. In a corrosive water supply, the water can attack copper parts and cause them to fail.

Where the saturation index exceeds $+0.40$, the water is very scaling and an expansion control valve* must be fitted on the cold water line after the non-return valve. The Rheem warranty does not apply to the water heater.

Water which is scaling may be treated with a water softening device to reduce the saturation index of the water.

* Refer to the [cold water connection detail on page 28](#).

CHLORIDE AND PH

Where the chloride level exceeds 250 mg/L the Rheem warranty does not apply to the water heater. In a high chloride water supply, the water can corrode stainless steel parts and cause them to fail.

WATER SUPPLIES

Where the pH is less than 6.0 the Rheem warranty does not apply to the water heater. pH is a measure of whether the water is alkaline or acid. In an acidic water supply, the water can attack stainless steel parts and cause them to fail.

Water with a pH less than 6.0 may be treated to raise the pH. The water supply from a rainwater tank in a metropolitan area is likely to be corrosive due to the dissolution of atmospheric contaminants.

SUMMARY OF WATER CHEMISTRY ADVICE AFFECTING THE RHEEM WARRANTY

The water heater is not suitable for certain water chemistries. Those chemistries are listed below. If the water heater is connected at any time to a water supply with the following water chemistry, Rheem's warranty will not cover any resultant faults:

Water Chemistry

Saturation Index (SI) < -1.0

Saturation Index (SI) > +0.4

Chloride > 250 mg/L

pH < 6.0

Component

water heater

water heater

water heater

water heater

SAVE A SERVICE CALL

Check the items below before making a service call. You will be charged for attending to any condition or fault that is not related to manufacture or failure of a part.

NOT ENOUGH HOT WATER (OR NO HOT WATER)

- **Is the electricity switched on?**

Inspect the isolating switch marked “HOT WATER” or “WATER HEATER” at the switchboard and the isolating switch (if one is installed) at the water heater and ensure they are turned on.

Check the fuse marked “HOT WATER” or “WATER HEATER” at the switchboard.

- **Is a timer installed?**

If a timer has been installed, ensure sufficient time has been allowed to reheat the storage tanks.

- **Are you using more hot water than you think?**

Are outlets (especially the showers) using more hot water than you think? Very often it is not realised the amount of hot water used, particularly when showering. Carefully review the hot water usage. Have your plumber install a flow control valve to each shower outlet to reduce water usage.



- **Heat pump controller or circulator has failed?**

The heat pump will not operate if the heat pump controller or circulator has failed. Refer to “[Heat Pump Is Not Operating](#)” on page 15 . Phone your nearest Rheem Service Department or Accredited Service Agent to arrange for an inspection.

- **Water heater size**

Do you have the correct size water heater for your requirements? The sizing guide in the sales literature and on the Rheem website (www.rheem.com.au) suggest average sizes that may be needed.

- **Air temperature is cold – defrost mode**

If this method of low ambient temperature operation is used, the heat pump will enter a defrost mode when ice is sensed on the evaporator coil. The recovery rate of the heat pump is reduced in this mode due to the lower operating air temperature and heating of water is reduced during the defrost cycle.

SAVE A SERVICE CALL

WATER TOO HOT

The water heater, during both normal heat pump operation and auxiliary booster operation (during periods of ambient temperatures below 7°C), will heat the water to a temperature of 60°C. It is recommended to set the auxiliary booster thermostat setting to 60°C.

WATER NOT HOT ENOUGH

You may find that due to heavy hot water usage the water temperature may be lower than normally expected, due to insufficient heating time being allowed. Additional storage or an in series booster may be required to be installed under these circumstances.

HEAT PUMP IS NOT OPERATING

- **Air temperature is cold – auxiliary boost mode**

If this method of low ambient temperature operation is used the heat pump will not operate when the air temperature is below 7°C and the auxiliary water heater, if installed, will operate instead. The total storage tank capacity will be heated to 60°C during these periods. Heating of the water by the heat pump will occur when the air temperature increases to 9°C or higher.

- **Thermal cut out activated**

Has the thermal cut out for the heat pump compressor activated?

If the thermal cut out has activated, the heat pump will not operate for a period of 20 minutes. The water heater will make two more attempts to start. If the thermal cut out is tripped again after the third attempt, the system will enter lock out and the alarm contacts will close. If connected to a BMS, this will alert the user that the unit is not operating.

To check whether there may be a problem, switch the power to the water heater off and on again at the circuit breaker to the water heater, then open a hot tap and allow to run for ten to fifteen minutes. The heat pump, if working properly, will activate and continue operating to heat the water. Close the hot tap when the heat pump begins to operate.

However, if the heat pump deactivates within five minutes, there may be a problem. Phone your nearest Rheem Service Department or Accredited Service Agent to arrange for an inspection.

SAVE A SERVICE CALL

- **Incorrect Phase Rotation**

The phase fail relay will open circuit if the heat pump has been wired with incorrect phase rotation or if a phase has failed. Both red and green LEDs on the relay will be illuminated if all phases are available and phase rotation is correct.

- **Heat pump wall controller or circulator has failed**

If the heat pump wall controller or circulator has failed, the heat pump will not operate. Wall controller faults are displayed behind the controller front cover. The controller contains live parts and **MUST** only be accessed by a licensed person. Phone your nearest Rheem Service Department or Accredited Service Agent to arrange for an inspection.

HIGH ELECTRICITY BILLS

With the installation of your new air sourced heat pump water heater, maximum electrical energy savings can be achieved. Should you at any time, feel your energy account is too high, we suggest you check the following points:

- Is the relief valve in the storage tanks running excessively?
- Are outlets (especially the showers) using more hot water than you think? (Refer to “**Not Enough Hot Water**” on page 14).
- Is there a leaking hot water pipe, dripping hot water tap, etc? Even a small leak will waste a surprising quantity of hot water and energy. Replace faulty tap washers, and have your plumber rectify any leaking pipe work.
- Consider recent changes to your hot water usage pattern and check if there has been any increase in tariffs since your previous account.
- The heat pump water heater operates at its most efficient at higher air temperatures. Prolonged periods of low ambient temperature will decrease the efficiency of the system and increase running costs.

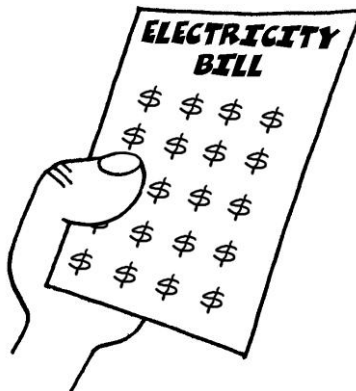

IF YOU HAVE CHECKED ALL THE FOREGOING AND STILL BELIEVE YOU NEED ASSISTANCE, CALL YOUR NEAREST RHEEM SERVICE DEPARTMENT OR ACCREDITED SERVICE AGENT.

INSTALLATION

**THIS WATER HEATER IS FOR INDOOR OR OUTDOOR INSTALLATION DEPENDING ON THE MODEL.
THIS WATER HEATER IS NOT SUITABLE FOR POOL HEATING.**

INSTALLATION STANDARDS

The water heater must be installed:

- by a qualified person, and
- in accordance with the installation instructions, and
- in compliance with Standards AS/NZS 3500.4, AS/NZS 3000 and all local codes and regulatory authority requirements.

In New Zealand, the installation must also conform with Clause G12 of the New Zealand Building Code.

WATER HEATER APPLICATION

This water heater is designed for the purpose of heating potable water. Its use in an application other than this may shorten its life

If this water heater is to be used where an uninterrupted hot water supply is necessary for the application or business, then there should be redundancy within the hot water system design. This should ensure the continuity of hot water supply in the event that this water heater was to become inoperable for any reason. We recommend you provide advice to the system owner about their needs and building backup redundancy into the hot water supply system.

COMPONENTS

The heat pump water heater system is modular and comprises four main components: the heat pump water heater, storage tanks, heat pump wall controller and primary circulator. An auxiliary booster and circulator may also be employed as part of the system.–The water heater must not be operated until all components are assembled.

Do not tilt the heat pump more than 45° from the vertical. This will unsettle the refrigerant gas and compressor lubricating oil. If the heat pump has been tilted more than 45° from the vertical during handling, it will need one hour to settle before the power to the water heater can be switched on, otherwise damage to the compressor may result.

INDOOR INSTALLATION

To comply with AS1677.2, the minimum room size permissible is 7.5m³ per heat pump. A larger room size is recommended for efficient heat pump operation.

INSTALLATION

WATER HEATER LOCATION

Ducted models are designed to be connected to ducting to convey cold discharge air away from the heat pump air inlet. Non ducted models may be installed outdoors or indoors, without ducting, if a sufficient supply of heat energy is available. Good performance is obtained when the heat pump is supplied with a constant supply of fresh air. Failure to observe the above recommendations may lead to lower than expected performance or problematic operation of the heat pump.

The water heater should be installed close to the storage tanks and its position chosen with noise, safety and service in mind. Make sure the air inlet louvres and outlet grilles are clear of obstructions and shrubbery and they are unlikely to be touched by people (especially children).

It is advisable to install the water heater away from bedroom or living room windows as the system can generate a noise of between 61 and 70 dBA (at 3 metres from the water heater) whilst operating.

It is recommended the water heater be installed at ground or floor level.

The water heater must stand vertically upright.

Clearance must be allowed for servicing of the water heater. The water heater must be accessible without the use of a ladder or scaffold.

You must be able to read the information on the rating plate. Remember you may have to remove the entire water heater later for servicing.

A clearance of 600 mm is required from the air inlet louvres and 1200mm from the air outlet grilles of the non ducted model to any obstruction.

The water heater must not be installed in an area with a corrosive atmosphere where chemicals are stored or where aerosol propellants are released. Remember the air may be safe to breathe, but the chemicals may attack the materials used in the heat pump system.

SAFE TRAY

Where damage to property can occur in the event of the water heater leaking, the water heater must be installed in a safe tray. Construction, installation and draining of a safe tray must comply with AS/NZS 3500.4 and all local codes and regulatory authority requirements.

INSTALLATION

MAINS WATER SUPPLY

Where the mains water supply pressure exceeds that shown in the table below, an approved pressure limiting valve is required and should be fitted as shown in the installation diagram (refer to diagram on page 32).

Relief valve setting (430L storage tanks)	1000 kPa
Expansion control valve setting *	850 kPa
Relief valve setting (1000L storage tanks)	700kPa
Expansion control valve setting *	550 kPa
Max-supply pressure (430L storage tanks)	
Without expansion control valve	800 kPa
With expansion control valve	680 kPa
Max-supply pressure (1000L storage tanks)	
Without expansion control valve	550 kPa
With expansion control valve	450 kPa

* Expansion control valve not supplied with the water heater.

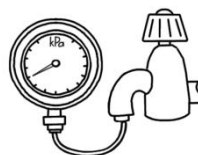

TANK WATER SUPPLY

If the storage tank is supplied with water from a tank supply and a pressure pump system is not installed, then the bottom of the supply tank must be at least 1 m above the highest point of the hot water plumbing system, including the storage tank. Care must be taken to avoid air locks. The cold water line to the storage tank should be adequately sized and fitted with a full flow gate valve or ball valve.

HOT WATER DELIVERY

This water heater can deliver water at temperatures which can cause scalding.

It is necessary and we recommend that a temperature limiting device be fitted between the storage tanks and the hot water outlets in any ablution area such as a bathroom or ensuite, to reduce the risk of scalding. The installing plumber may have a legal obligation to ensure the installation of this water heater system meets the delivery water temperature requirements of AS/NZS 3500.4 so that scalding water temperatures are not delivered to a bathroom, ensuite or other ablution area.

Where a temperature limiting device is installed adjacent to the storage tanks, the cold water line to the temperature limiting device can be branched off the cold water line either before or after the isolation valve, pressure limiting valve and non return valve to the water heater system. If an expansion control valve is required, it must always be installed after the non return valve and be the last valve prior to the storage tanks.

INSTALLATION

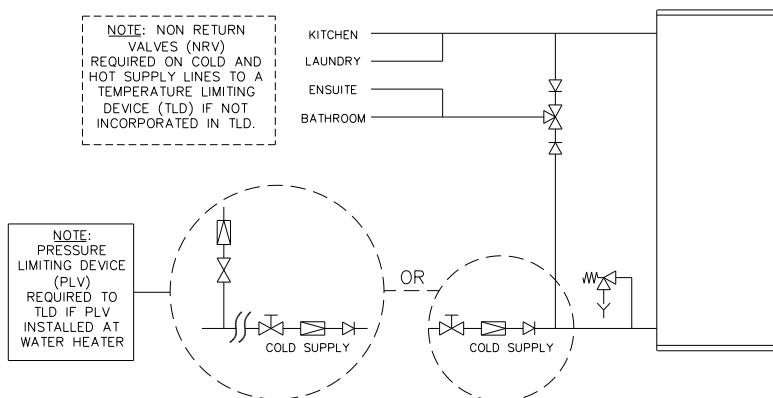

Two Temperature Zones Using a Temperature Limiting Device

If a pressure limiting valve is installed on the cold water line to the water heater system and the cold water line to a temperature limiting device branches off before this valve or from another cold water line in the premises, then a pressure limiting valve of an equal pressure setting may be required prior to the temperature limiting device.

CIRCULATED HOT WATER FLOW AND RETURN SYSTEM

A heat pump water heater should not be installed as part of a circulated hot water flow and return system in a building.

If a circulated hot water flow and return system is required, it is necessary to install a secondary water heater in the hot water return line. The secondary water heater must have a thermostat setting of at least 60°C. [Refer to the diagram on page 26.](#)

Temperature Limiting Device

A temperature limiting device cannot be installed in circulated hot water flow and return pipe work unless the device is designed for such application, such as Rheem Guardian. The tempered water from a temperature limiting device cannot be circulated. Where a circulated hot water flow and return system is required in a building, a temperature limiting device can only be installed on a dead leg, branching off the circulated hot water flow and return pipe.

INSTALLATION

If circulated tempered water were to be returned back to the water heater, depending on the location of the return line connection on the water supply line to the water heater, then either:

- water will be supplied to the cold water inlet of the temperature limiting device at a temperature exceeding the maximum recommended water supply temperature, or
- when the hot taps are closed no water will be supplied to the cold water inlet of the temperature limiting device whilst hot water will continue to be supplied to the hot water inlet of the temperature limiting device.

These conditions may result in either water at a temperature exceeding the requirements of AS/NZS 3500.4 being delivered to the hot water outlets in the ablution areas, or the device closing completely and not delivering water at all, or the device failing. Under either condition, the operation and performance of the device cannot be guaranteed.

INSULATION

To minimise heat loss and provide protection from freezing, the cold water line to and the hot water line from the heat pump water heater must be insulated in accordance with the requirements of AS/NZS 3500.4. The insulation must be weatherproof and UV resistant if exposed.

SADDLING - PIPE WORK

To prevent damage to the heat pump and storage tanks when attaching pipe clips or saddles to the water heater jacket, we recommend the use of self-drilling screws with a maximum length of 12 mm. Should pre drilling be required, extreme caution must be observed when penetrating the jacket of the water heater.

Avoid drilling or saddling in the vicinity of the evaporator coil. The coil and refrigerant circuit are in close proximity to the jacket and rupturing of the refrigerant circuit may occur.

Note: If the heat pump is damaged as a result of attaching pipe clips or saddling to the jacket, any resultant faults will not be covered by the Rheem warranty.

INSTALLATION

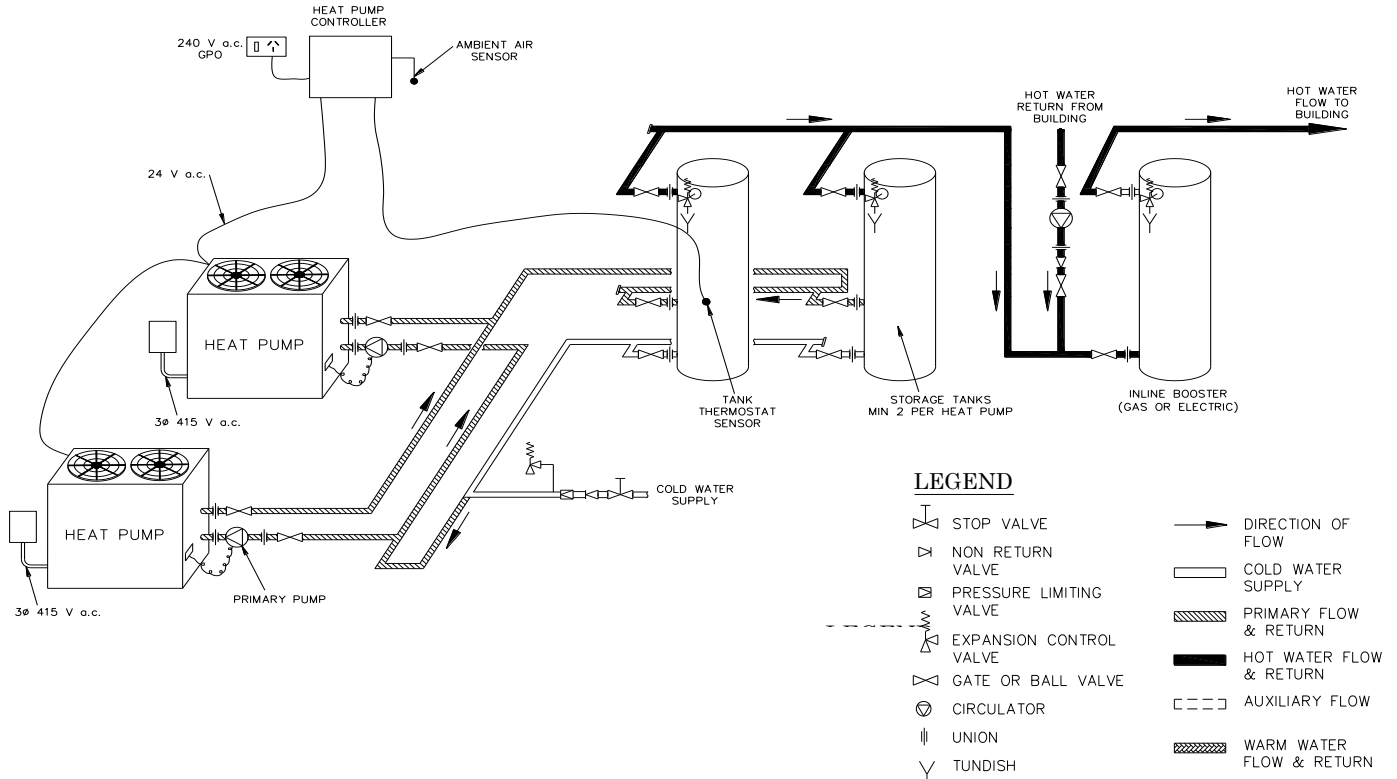

**TYPICAL INSTALLATION
IN LINE BOOSTER, CIRCULATED HOT WATER FLOW AND RETURN**

INSTALLATION

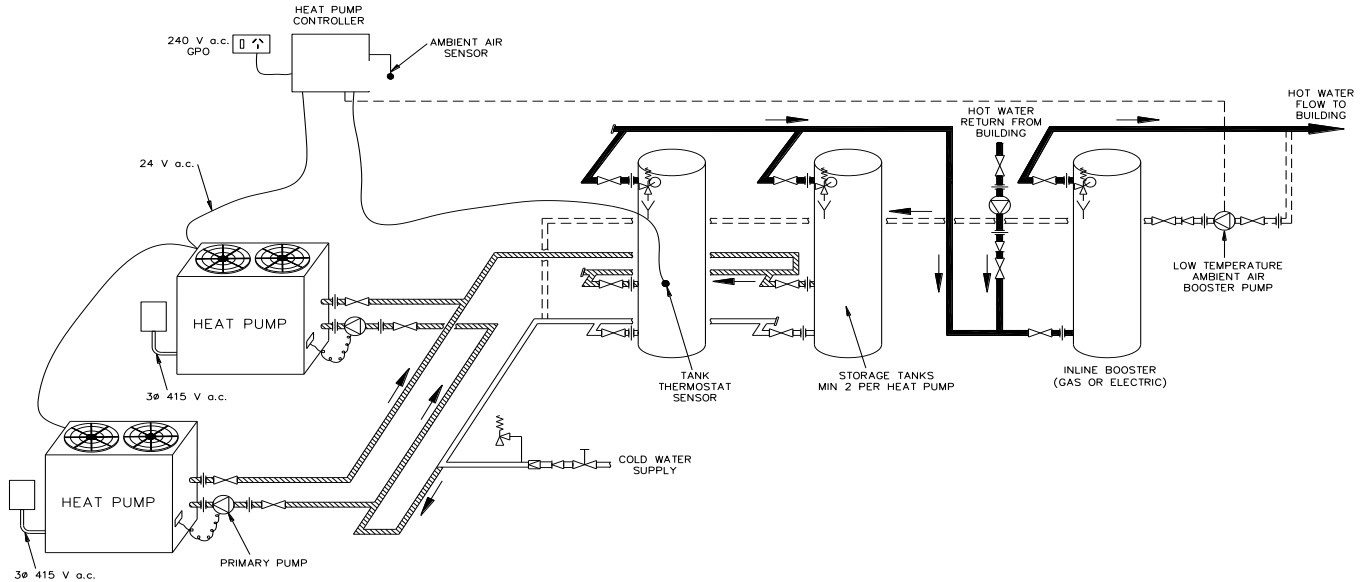

**TYPICAL INSTALLATION
IN LINE BOOSTER, CIRCULATED HOT WATER FLOW AND RETURN, LOW AMBIENT AIR BOOST**

INSTALLATION

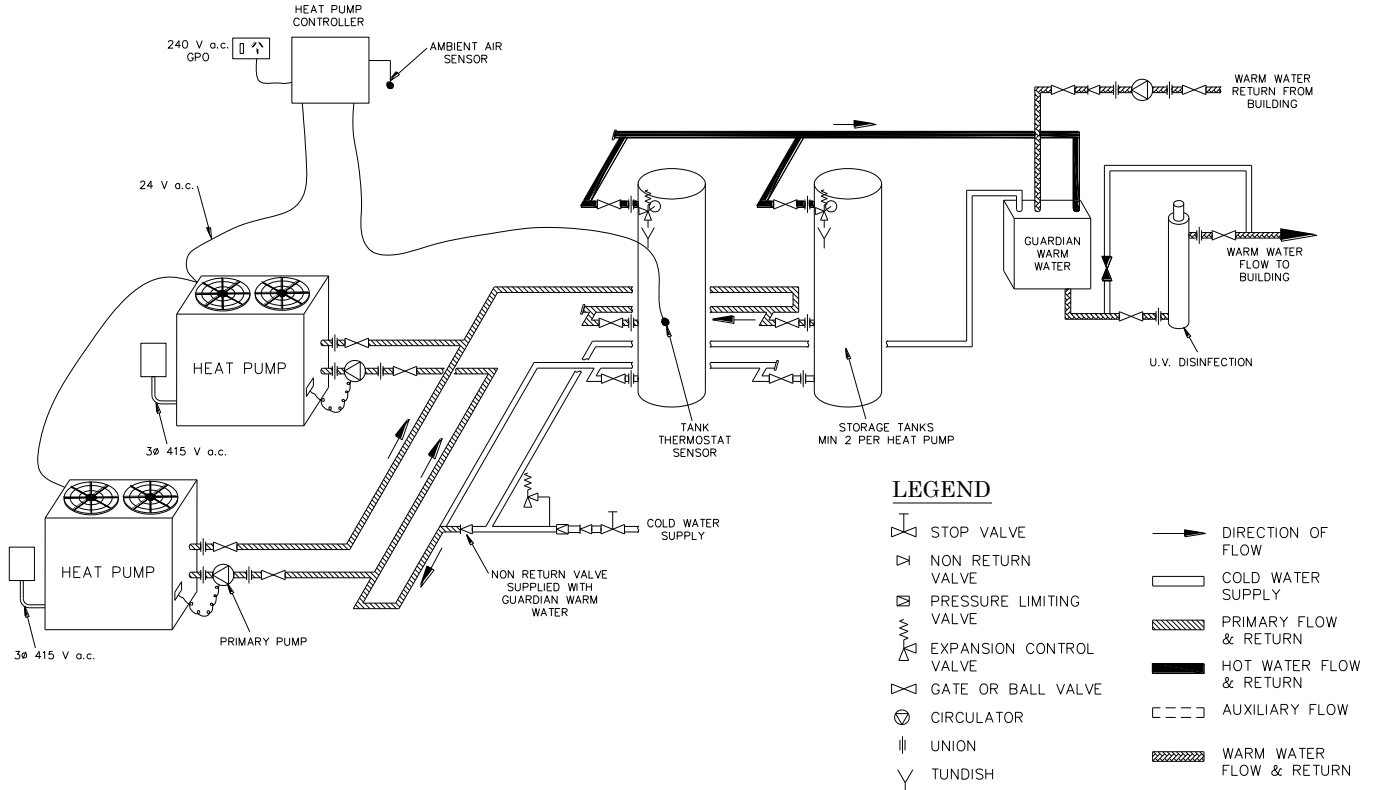

**TYPICAL INSTALLATION
WITH GUARDIAN WARM WATER**

INSTALLATION

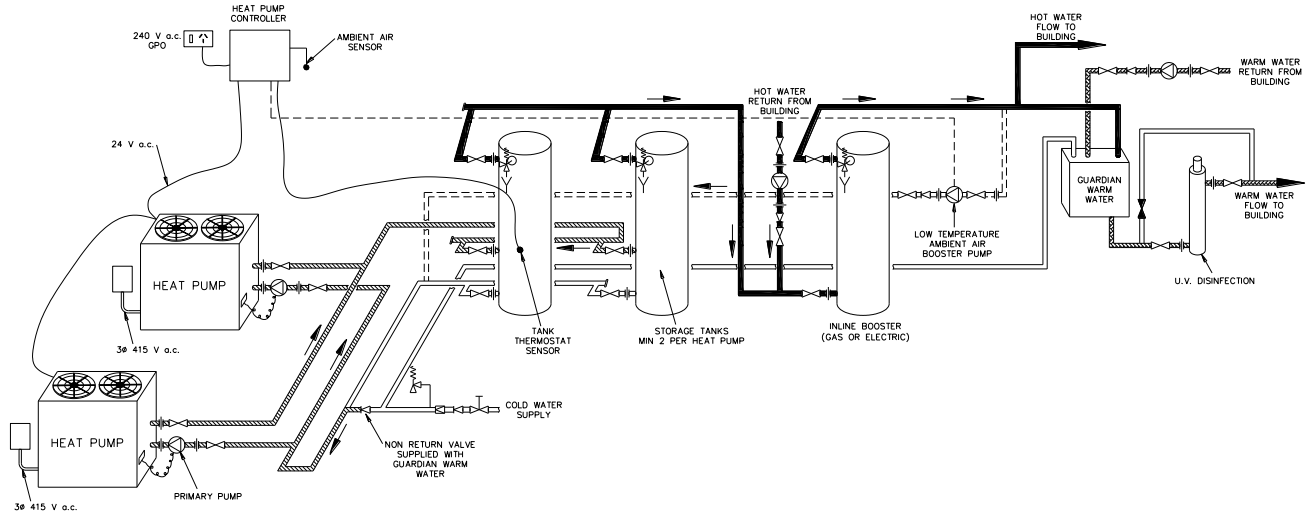

**TYPICAL INSTALLATION
IN LINE BOOSTER, CIRCULATED HOT WATER FLOW AND RETURN,
LOW AMBIENT AIR BOOST AND GUARDIAN WARM WATER**

INSTALLATION

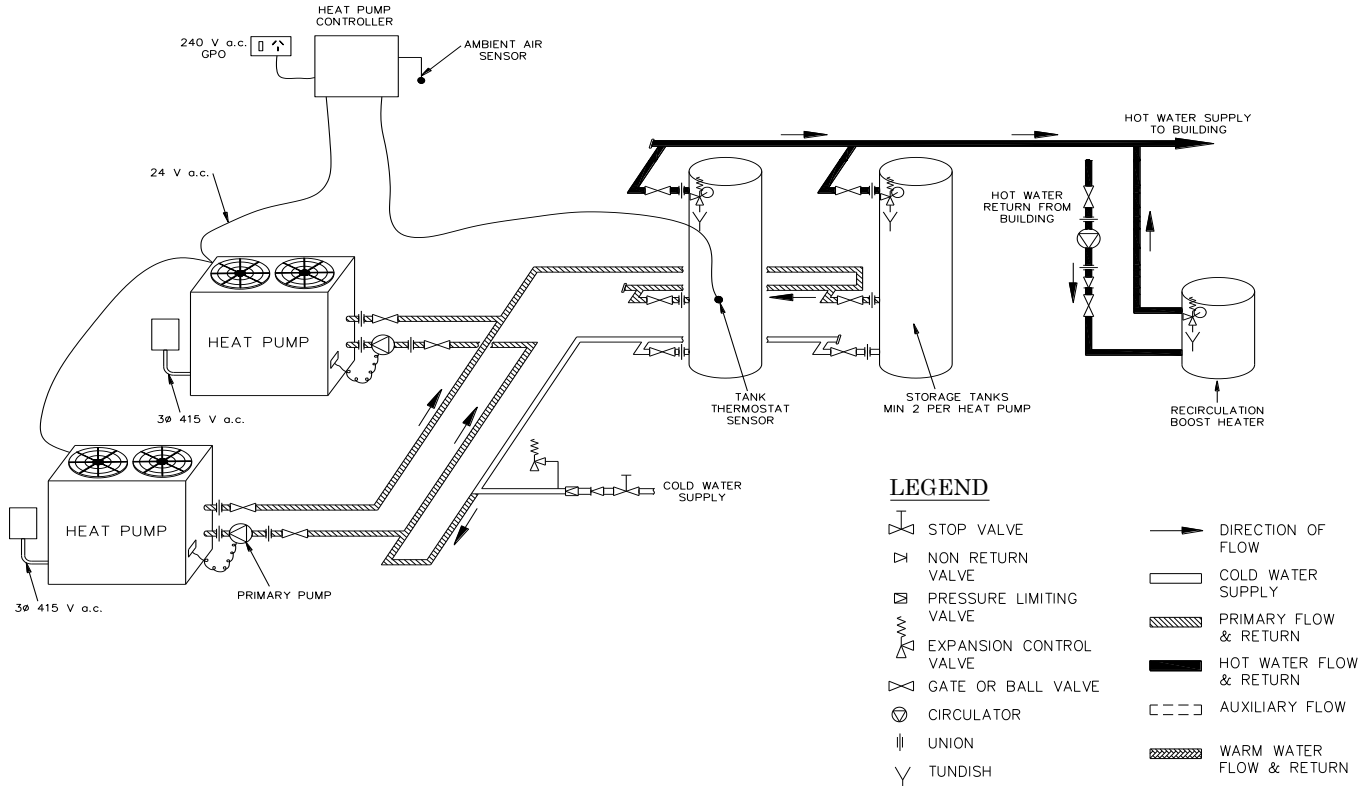

TYPICAL INSTALLATION RECIRCULATION BOOST

INSTALLATION

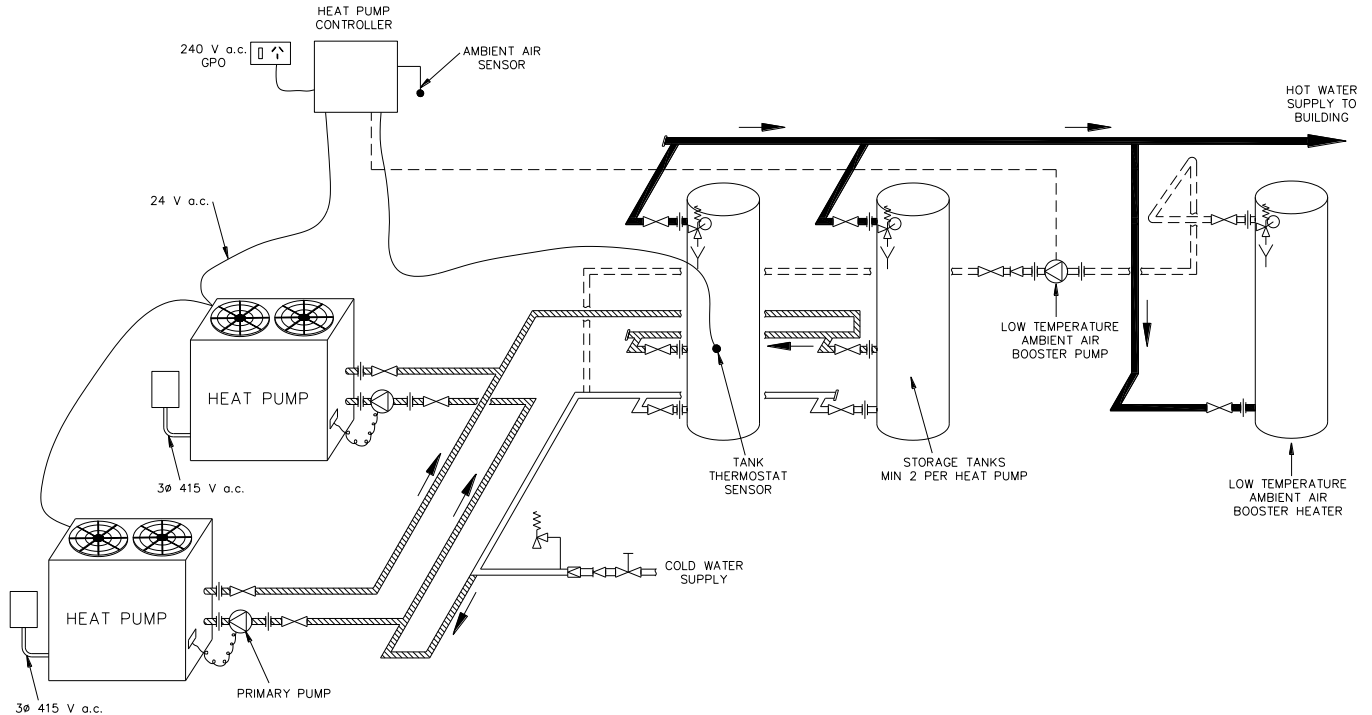

**TYPICAL INSTALLATION
LOW AMBIENT AIR BOOST DEAD LEG SYSTEM**

INSTALLATION

DIMENSIONS AND TECHNICAL DATA

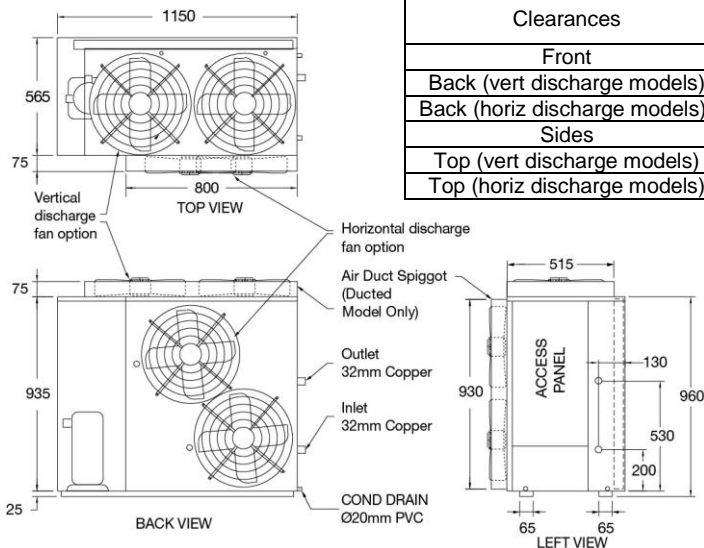

Clearances	Ducted	Non Ducted
Front	600	600
Back (vert discharge models)	50	50
Back (horiz discharge models)	1200	1200
Sides	600	600
Top (vert discharge models)	800	1200
Top (horiz discharge models)	50	50



FRONT VIEW

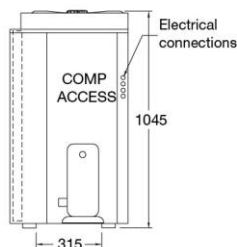

RIGHT VIEW

Model	952 022 (ducted) / 953 022 (non ducted)
Rated heat pump power input	4200 watts
Refrigerant type	R407C
Refrigerant circuit pressure	3379 kPa
Refrigerant charge	1.8kg
Mass empty	120 kg
Mass full	125 kg

Specifications are subject to change with ongoing product improvements.

HEAT PUMP AND TANK ASSEMBLY

HEAT PUMP AND STORAGE TANKS

The heat pump water heater system is modular and comprises four main components: the heat pump water heater, storage tanks, heat pump wall controller and primary circulator. An auxiliary booster and circulator may also be employed as part of the system. The water heater must not be operated until all components are assembled.

HEAT PUMP

Locate the heat pump(s) in the appropriate position observing the required clearances for operation and servicing. [Refer to page 28](#)

Indoor Installations

To comply with AS1677.2, the minimum room size permissible is 7.5m³ per heat pump. A larger room size is recommended for efficient heat pump operation.

Ducted models are designed to be connected to ducting to convey cold discharge air away from the heat pump air inlet. Non ducted models may be installed indoors, without ducting, if a sufficient supply of heat energy is available. Good performance is obtained when the heat pump is supplied with a constant supply of fresh air. Failure to observe the above recommendations may lead to lower than expected performance or problematic operation of the heat pump.

Ventilation

The heat pump draws fresh air at a rate of 1.6m³/s. Minimum recommended free air inlet ventilation opening is 1m² per heat pump.

Exhaust

The exhaust air duct must be constructed so that it covers both fans. A spigot is provided on ducted models to facilitate ductwork connection. The maximum static pressure in the ductwork must not exceed 40Pa.

Horizontal Ducting

For vertical discharge fan models the horizontal duct should be at least 800mm high and as short as practicable.

For horizontal discharge fan models the horizontal duct should be the dimensions of the spigot.

It is recommended to terminate the duct with bird mesh to minimise the resistance to air flow. If louvres are to be used, the duct size must be increased. The duct should have a slight fall away from the heat pump and the terminal face oriented downwards to prevent water ingress.

HEAT PUMP AND TANK ASSEMBLY

Vertical Ducting

Vertical ducting is not recommended.

Horizontal Fan Option

If a horizontal discharge fan option has been selected, the same rules apply to location of installation as for ducted and non ducted models, depending on which has been ordered. If installed indoors, observe the same requirements as shown in indoor installations on [page 29](#)

Horizontal discharge fan heat pumps may be stacked one on top of the other, for a maximum of two high. Install anti vibration mats between stacked pairs.

STORAGE TANKS

Rheem Commercial storage tanks are employed to store the hot water generated by the heat pump. The tanks must be manifolded using the Equa-Flow[®] manifold system to ensure even distribution of the stored energy. Up to eight tanks can be manifolded together in a single bank. More than one bank can be used. Follow the diagram on [page 40](#) when manifolding the tanks.

Refer to the installation instructions supplied with the storage tanks for specific information relating to the installation of the storage tanks.

PRIMARY CIRCULATOR

Each heat pump requires a primary circulator to ensure the correct flow rate and temperature rise is achieved. Where more than one heat pump is installed the common manifold must be installed using the Equa-Flow[®] manifold system and must be sized to accommodate the total flow of all the primary pumps running simultaneously. Refer to table below for minimum pipe sizing.

Heat Pump Pipe Sizing Chart						
	Number of Heat Pumps in Parallel					
	1	2	3	4	5	6
Primary Pump	Grundfos UPS32-80N					
Branch Size	32mm	32mm	32mm	32mm	32mm	32mm
Header Size	32mm	50mm	65mm	65mm	80mm	80mm

The designed primary pump is Grundfos model UPS32-80N installed with the shaft in the horizontal orientation and set on speed 3. Refer to installation manual supplied with pump. If another pump has been supplied, consult Rheem before continuing with the installation.

Header pipe sizing is based on a total length of 20m of primary flow and return piping and 10 x 90° bends, excluding Equa-flow manifolds on storage tanks and heat pumps. If this specification is exceeded consult Rheem before continuing with the installation.

HEAT PUMP AND TANK ASSEMBLY

WALL CONTROLLER

A heat pump wall controller is required to operate the heat pumps and auxiliary circulator (if installed). [Refer to page 35](#) for installation details.

AUXILIARY WATER HEATER

It may be necessary to install an auxiliary water heater under the following conditions:

- If the hot water supply is part of a flow and return circuit.
- If the ambient temperature is likely to drop below 5°C during periods when heating may be required and de-ice is not being relied upon.
- To ensure sufficient hot water is available for higher than expected peak conditions.
- If higher temperature water is required for certain applications, eg commercial laundry or kitchen.

The configuration of the auxiliary water heating plant can vary depending on the requirements of the individual installation.

Recirculation Heat Loss Only - Where the auxiliary water heater is only required to make up heat losses in the secondary hot water flow and return circuit, the auxiliary water heater may be installed with the return water entering the inlet of the auxiliary water heater and the outlet from the auxiliary water heater branching from the secondary hot water flow pipe. [Refer to page 26.](#)

Low Ambient Temperature Heating Only - Where the auxiliary water heater is required to be activated if the heat pump cannot operate due to low ambient air conditions, the auxiliary water heater may be installed with a branch from the secondary hot water flow pipe entering the inlet of the auxiliary water heater and the outlet from the auxiliary water heater connecting to the primary hot water flow from the heat pump(s). A circulator and non return valve must be installed in the hot water flow from the auxiliary water heater. [Refer to page 27.](#)

In Line Boosting Only - Where the auxiliary water heater is required to ensure sufficient hot water is available for periods after the main peak or to boost the temperature of the water produced by the heat pump for other purposes (eg high temperature for kitchen and laundry use), auxiliary water heater(s) must be installed in series with the storage tanks. ie, the hot water outlet from the storage tanks must feed into the inlet of the auxiliary water heater(s). Where multiple auxiliary water heaters are required to be manifolded together, these must be manifolded using the Equa-Flow[®] manifold system and the manifold in-series with the storage tanks. [Refer to page 41.](#)

This arrangement can also be adapted to include recirculation heat loss make up and / or low ambient temperature heating. [Refer to page 25.](#)

CONNECTIONS – PLUMBING

CONNECTION SIZES

- Heat pump water heater inlet connection: 32mm copper.
- Heat pump water heater outlet connection: 32mm copper.
- Condensate drain connection: 20mm O.D. PVC.

All plumbing work must be carried out by a qualified person and in accordance with the Plumbing Standard AS/NZS 3500.4 and local authority requirements.

WATER INLET AND OUTLET

The pipe work must be cleared of foreign matter before connection and purged before attempting to operate the water heater. All olive compression fittings must use brass or copper olives. Use thread sealing tape or approved thread sealant on all screwed fittings.

An isolation valve and non return valve must be installed on the cold water line to the water heater system. An acceptable arrangement is shown in the diagram. Refer also to “Hot Water Delivery” on page 19 and to “Mains Water Supply” on page 19.

Disconnection unions must always be provided at the cold water inlet and hot water outlet on the water heater to allow for disconnection of the water heater.

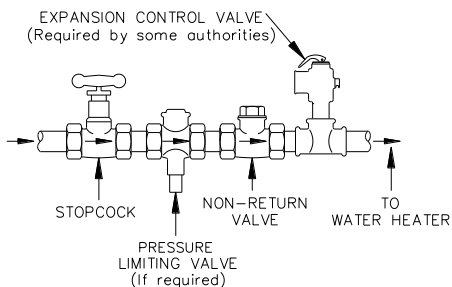

PIPE SIZES

To achieve true mains pressure operation, the cold water line to the storage tanks should be the same size or bigger than the hot water line from the storage tanks.

The pipe sizing for hot water supply systems should be carried out by persons competent to do so, choosing the most suitable pipe size for each individual application. Reference to the technical specifications of the water heater and local regulatory authority requirements must be made.

Refer to the table on page 30 for correct primary flow and return pipe sizing.

CONNECTIONS - PLUMBING

RELIEF VALVE DRAIN

A pressure relief valve is supplied fitted to the water heater. A copper drain line must be fitted to the relief valve to carry the discharge clear of the water heater. Connect the drain line to the relief valve using a disconnection union. The pipe work from the relief valve to the drain should be as short as possible and fall all the way from the water heater with no restrictions. It should have no more than three right angle bends in it. Use DN15 pipe.

The outlet of the drain line must be in such a position that flow out of the pipe can be easily seen (refer to AS/NZS 3500.4) - but arranged so hot water discharge will not cause injury, damage or nuisance. The drain line must discharge at an outlet or air break not more than 9 metres from the relief valve.

In locations where water pipes are prone to freezing, the drain line must be insulated and not exceed 300 mm in length. In this instance, the drain line is to discharge into a tundish through an air gap of between 75 mm and 150 mm.

⚠ Warning: As the function of the pressure relief valve on this water heater is to discharge high temperature water under certain conditions, it is strongly recommended the pipe work downstream of the relief valve be capable of carrying water exceeding 93°C. Failure to observe this precaution may result in damage to pipe work and property.

EXPANSION CONTROL VALVE

Local regulations may make it mandatory to install an expansion control valve (ECV) in the cold water line to the water heater system. In other areas, an ECV is not required unless the saturation index is greater than +0.4 (refer to “Water Supplies” on page 12). However, an ECV may be needed in a corrosive water area where there are sufficient quantities of silica dissolved in the water.

The expansion control valve must always be installed after the non return valve and be the last valve installed prior to the water heater system (refer to diagram on page 32). A copper drain line must be run separately from the drain of the relief valve.

CONDENSATE DRAIN

A drain line must be fitted to the condensate drains to carry the discharge clear of the water heater. The drain line can be extended using 20 mm O.D. rigid hose or conduit. Where installed externally, the drain line pipe work must be UV resistant or protected from sunlight. The outlet of the drain line must be in such a position that flow out of the pipe can be easily seen - but arranged so water discharge will not cause damage or nuisance. It is recommended to install the water heater with a slight fall towards the condensate drain.

The condensate drain line must not be connected to the pressure relief valve drain line but may discharge at the same point.

CONNECTIONS – ELECTRICAL

The power supply to the water heater must not be switched on until the water heater is filled with water and a satisfactory megger reading is obtained.

MEGGER READING

When a megger test is conducted on this water heater, then the following should be noted.

⚠ Warning: This water heater contains electronic equipment and 500 V insulation tests must only be conducted between actives and earth and between neutral and earth. An active to neutral test WILL damage the electronics.

An insulation test result of above 1 MΩ should be obtained for this water heater.

ELECTRICAL CONNECTION

All electrical work and permanent wiring must be carried out by a qualified person and in accordance with the Wiring Rules AS/NZS 3000 and local authority requirements.

Heat Pump

The heat pump water heater must be directly connected to a 415 V AC 50 Hz mains power supply. The heat pump must be on its own circuit with an isolating switch installed at the switchboard. A secondary isolating switch may be installed within reach of the water heater.

A conduit is required for the electrical cable to the heat pump water heater. The conduit is to be connected to the unit with a terminator. Connect the power supply and earth wires directly to the terminal block, ensuring there are no excess wire loops inside the electrical enclosure. Correct phase connection is required.

Primary Circulator

The power to the primary circulator for each heat pump water heater is supplied from the water heater. Connect the active, neutral and earth wire to the circulator terminals and to the terminals located within the heat pump electrical enclosure. A flexible 20 mm conduit is required for the electrical cable between the water heater and circulator. The conduit is to be connected to the water heater with a 20 mm terminator.

CONNECTIONS – ELECTRICAL

Heat Pump Wall Controller

The Rheem Commercial Heat Pump Wall Controller controls most operations of the water heater system. The system will not operate if a controller has not been installed.

Enclosure Installation

It is suggested to install the controller after the heat pumps and storage tanks have been installed.

The controller is suitable to be wall mounted indoors or outdoors. Select a suitable location with the following in mind:

- The controller is supplied with a 1.5m long plug and flex for connection to a GPO. The GPO must be weatherproof if installed outdoors.
- Two thermistors are supplied. The tankstat sensor has a 12m lead and is to be installed in any one of the storage tanks. The ambient sensor has a 3m lead and is to be located in proximity to one of the heat pumps.

Mount the controller to the wall via the mounting holes located inside the enclosure using suitable anchors. Do not connect the power.

Tankstat Sensor Installation

- Run out the sensor marked “Tank Sensor” to the nearest storage tank.
- A thermostat well is supplied within each tank.
- Remove the plastic cover from the fitting located 90° from the water connections on the storage tank, but do not discard.
- Make a small hole in the centre of the plastic cap and thread the sensor through the hole.
- Insert the sensor all the way into the thermostat well and fit the plastic cap back onto the storage tank.
- Seal the hole in the plastic cap using silicone or similar.
- Cable tie the sensor lead, curling up and tying off any excess lead.

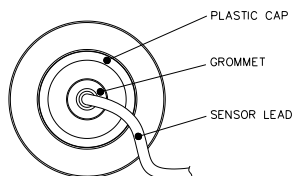
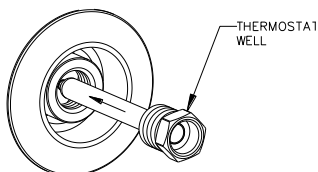

CONNECTIONS – ELECTRICAL

Ambient Sensor Installation

- Run out the sensor marked “Ambient Sensor” to a position in proximity to the air inlet of the heat pump but not in the direct line of the air discharge of the heat pumps.
- Mount the sensor in the chosen location.

NOTE: The purpose of the ambient sensor is to switch over heat pump operation to auxiliary boost mode when low ambient conditions are present. The sensor position should be chosen to provide a representative reading of the local conditions.



Use the following as a guide:

- Ideally, fit the sensor between the louvres of the air inlet of one of the heat pumps.
- Position the sensor in the same location as the heat pump i.e. indoors or outdoors
- Do not locate the sensor in the air discharge from the heat pumps
- Do not locate the sensor where hot or cold air is being discharged from other equipment
- Cable tie the sensor lead, curling up and tying off any excess lead.

Connecting the Water Heaters

- Ensure power to the water heaters is isolated.
- The control signal from the wall controller to the water heaters is 24 volt and the wiring must be run separately from any 240V or 415V cabling.
- Run a two core sheathed cable from the terminals marked “24VAC” in the controller to the first water heater. A 20mm conduit gland is supplied and the cable carrying the 24 volt signal must be run in conduit.
- Insert the cable through the conduit hole on the water heater with a suitable terminal and connect to the terminals marked “HP1 / 2, 24V”. Note: the terminals are NOT polarity sensitive.

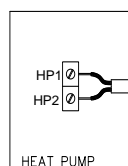
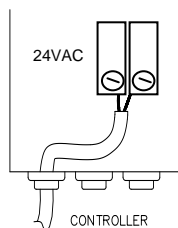

CONNECTIONS – ELECTRICAL

- If more than one heat pump water heater is installed, the 24 volt cable is daisy chained to each water heater in turn from the first water heater. Remove the bung from the water heater and run the 24 volt cable to the next water heater in conduit.

Connecting the Auxiliary Pump

Depending on the installation, a Low Ambient Temperature auxiliary pump and heater may be supplied. Connect this pump to the controller.

A typical installation may have all or some of the following pumps:

- Heat Pump primary circulator (mandatory) – located adjacent to and plumbed to each heat pump inlet. The primary pumps are wired into the heat pump.
- Building secondary circulator (optional) – connected between the building hot water return line and an auxiliary water heater.
- Low Ambient Temperature auxiliary pump (optional) – located between the auxiliary heater outlet and the cold water inlet manifold to the storage tanks.

Make connections to the auxiliary pump and terminals marked “Aux Pump” located in the wall controller enclosure. Ensure the pump is earthed.

Building Management Systems (BMS/BAS)

Each water heater can be connected to a BMS or BAS system to indicate run/fault status.

The BMS/BAS output signal is 12V DC. We recommend using the output signal to drive a relay.

Connect the BMS/BAS wires to the terminals marked “Common and Alarm” located behind the heat pump front cover. The BMS cable must be run in conduit.

CONNECTIONS – ELECTRICAL

TIMER

A timer can be added to the circuit prior to the controller if the customer requires the heat pumps do not operate between certain hours, such as during the night. The timer must be weatherproof if it is installed outdoors.

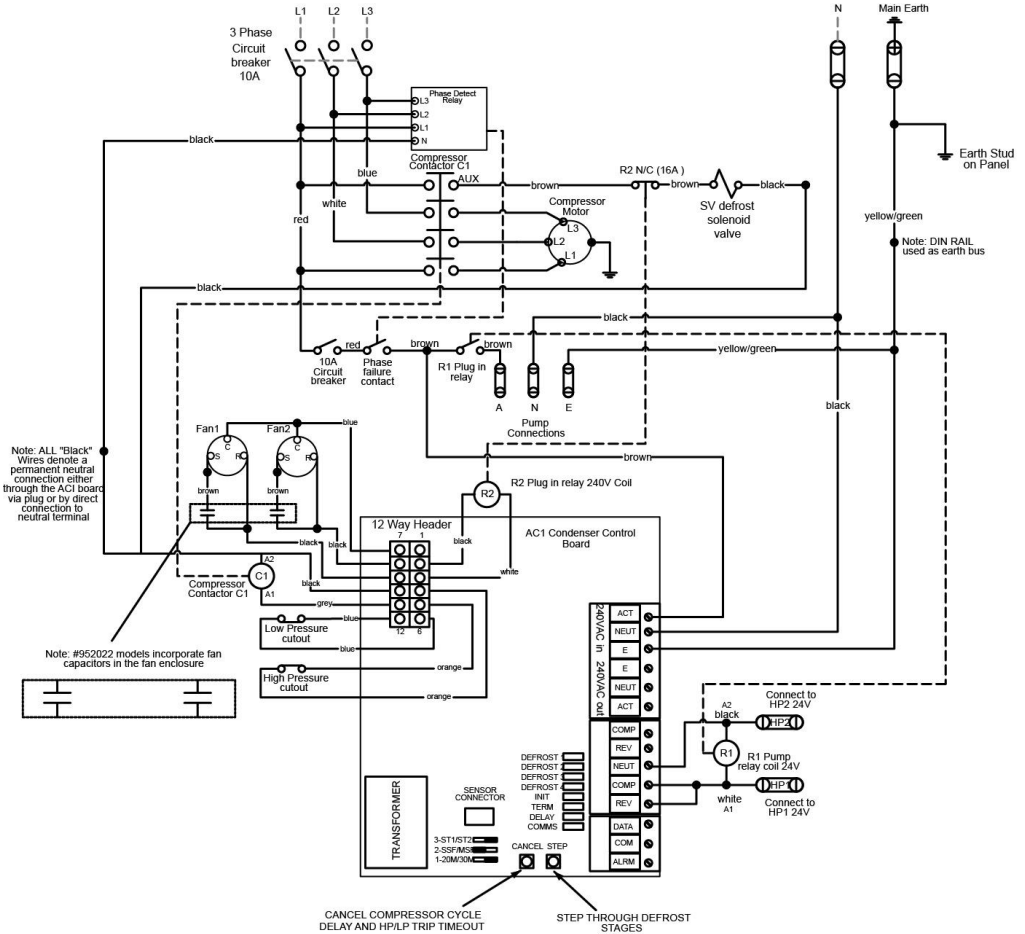

NOTE:
F1 CAPACITOR IS LOCATED ABOVE THE F2 CAP ON THE BOARD

Heat Pump Internal Wiring Diagram

MANIFOLD INSTALLATIONS

The Rheem commercial heat pump water heater is designed to be installed with storage tanks on a single manifold or multiple manifolds if required, using the Rheem Equa-Flow[®] manifold system. The Equa-Flow principle will function with water heaters in line, around a corner or in rows back to back ([refer to the diagrams on pages 40 to 41](#)).

The cold water, primary flow and hot water manifolds must be designed to balance the flow from each water heater and storage tank. To achieve this, there are basic installation requirements and principles which must be followed:

1. The maximum number of storage tanks in a bank should be 10, however several banks of storage tanks can be installed.
2. The hot water line from the manifold must leave from the opposite end to which the cold water line enters the manifold.
3. The storage tanks must be of the same model.
4. The cold water line, cold and hot headers and hot water line must be sized to meet the requirements of both AS/NZS 3500.4 and the application.
5. A non return valve, isolation valve and if required a pressure limiting valve and expansion control valve, must be installed on the cold water line to the system.
6. A full flow gate valve or ball valve (not a stop tap, as used on a single water heater installation) must be installed on both the cold water branch and hot water branch of each water heater and storage tank.
7. Non return valves or pressure limiting valves **MUST NOT** be installed on the branch lines to the water heaters or storage tanks.
8. All fittings, valves and branch lines must be matched sets all the way along the manifold.
9. Sufficient space must be left to enable access, servicing or removal of any water heater or storage tank.
10. The temperature pressure relief valve drain line from each storage tank can terminate at a common tundish (funnel) with a visible air break at each drain discharge point.

MANIFOLD INSTALLATIONS

Manifold Arrangement

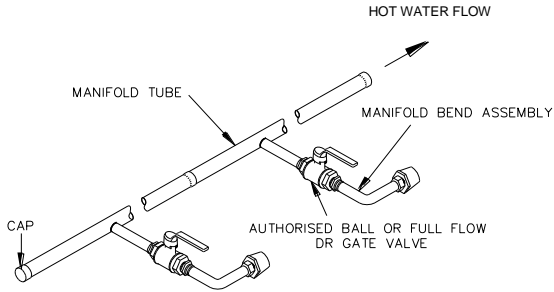

Hot Manifold Assembly

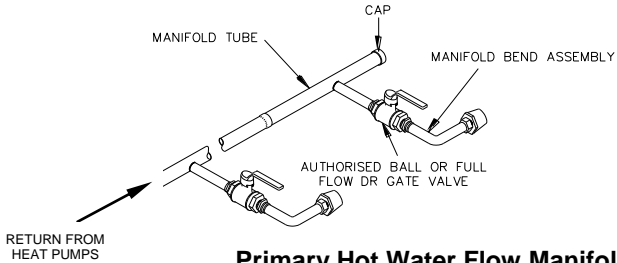

Primary Hot Water Flow Manifold Assembly

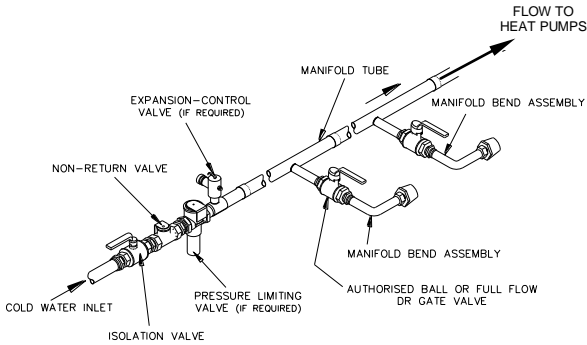

Cold Manifold Assembly

MANIFOLD INSTALLATIONS

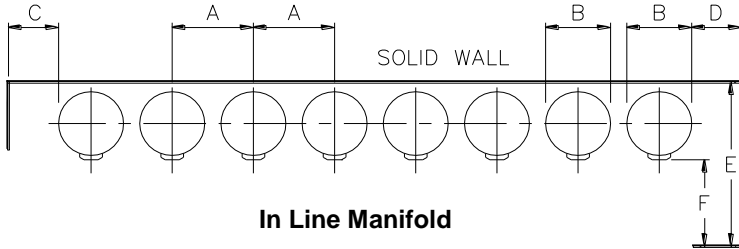

In Line Manifold

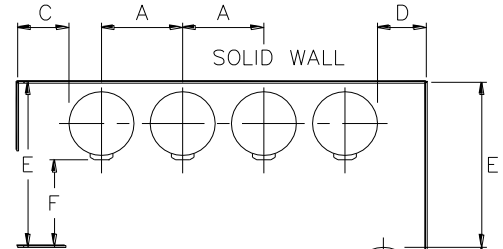

Angle Manifold

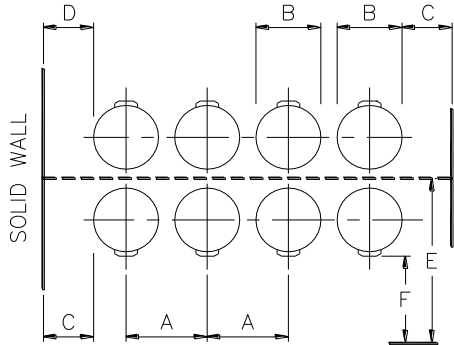

Back to Back Manifold

NOTES:
 Minimum recommended space between wall and back of water heater is 100 mm.
 A minimum of 900 mm (E* & F*) should be left in front of the water heater for access, servicing and water heater removal.

Installation Layout Minimum Dimensions						
Model	A	B	C	D	E *	F *
610 430	935	685	300	100	1685	900

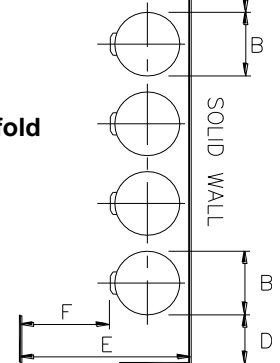

INSTALLATION DIMENSIONS – MULTIPLE RHEEM STORAGE TANKS

COMMISSIONING

TO FILL AND TURN ON THE WATER HEATER

The power supply to the water heater and controller must not be switched on until the water heater is filled with water and a satisfactory megger reading is obtained.

- Open all of the hot water tap(s) in the building (don't forget the shower(s)) and supply cock(s) and valve(s) in the system.
- Open the isolation valves fully on the cold, return and hot water branches to the storage tank(s) installed in a bank.
- Open the cold water isolation valve on the cold water line to the storage tank(s).

Air will be forced out of the taps.

- Close each tap as water flows freely from it.
- Check the pipe work for leaks.
- Switch on the electrical supply at the isolating switch to the water heater and controller.
- Set the timer if one is installed.

If the water heater is full of cold water, the fan will activate and heating will commence unless the ambient air temperature is below the ambient sensor set point, in which case the auxiliary circulator will operate, if installed.

It is important to wait for five minutes after the heat pump has activated to ensure it continues to operate and is functioning correctly.

Note: The water heater may not turn on immediately when it is first switched on, if it is switched on within 20 minutes of it having been switched off at the isolating switch, or the heat pump has just completed a heating cycle. The water heater will wait until the conditions for start up are favourable in order to protect the compressor from damage. This may take up to 20 minutes. The auxiliary booster (if installed) will operate instead of the heat pump if the ambient air temperature is less than the ambient sensor set point.

Explain to a responsible officer the functions and operation of the heat pump water heater. Upon completion of the installation and commissioning of the water heating system, leave this guide with the responsible officer.

TO TURN OFF THE WATER HEATER

If it is necessary to turn off the water heater on completion of the installation, such as on a building site or where the premises are vacant, then:

- Switch off the electrical supply at the isolating switch to the water heater and the controller.
- Close the cold water isolation valve at the inlet to the water heater.

DRAINING THE WATER HEATER

To drain the water heater:

- Turn off the water heater and controller (refer to “[To Turn Off The Water Heater](#)” on page 43)
- Close all hot water taps.
- Operate the relief valve release lever on one of the storage tanks - do not let the lever snap back or you will damage the valve seat.

Operating the lever will release the pressure in the water heater.

- Close the isolation valves at the inlet and outlet of the water heater and place a bucket under the cold water inlet.
- Undo the unions at the inlet and outlet of the water heater. The heat pump heat exchanger holds 5 litres of water and will drain into the bucket.

TROUBLE SHOOTING

• Heat Pump Won't Start

A delay of up to 20 minutes can be experienced before heat pump starts operating

• Incorrect Phase Rotation

The phase detect relay will open circuit if the heat pump has been wired with incorrect phase rotation or if a phase has failed. Both red and green LEDs on the relay will be illuminated if phase rotation is correct.

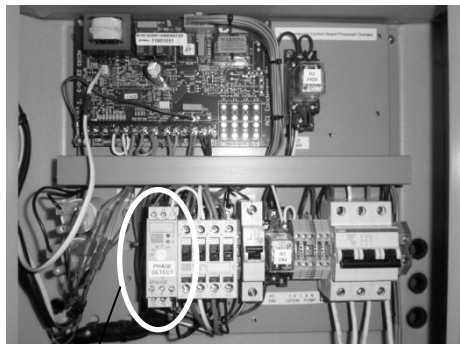

PHASE DETECT RELAY

- **Low Ambient Temperature**

If the ambient air temperature is below set point, the heat pump will not start. AUXILIARY PUMP LED in the wall controller will be illuminated.

Warning – live parts inside! – remove cover from wall controller. Refer to instructions contained within to view and adjust low ambient temperature cut in set point, if required.

- **Heat pump starts then turns off soon after**

Warning – Live parts inside! Remove heat pump electrical front cover and check ERR LED located on PC board in Heat Pump. If illuminated, heat pump safety has tripped due to over pressure or under pressure of refrigerant gas.

This could be caused by:

- a. Insufficient water flow rate through heat exchanger. Check pipe sizing per chart, check obstructions, check lines and pump are bled, check pump is operating.

Note: Tanks and heat pumps are to be manifolded in Equa-Flow. It is important that the branches to each storage tank **ONLY** contain a gate or ball valve and union. Fitting of loose jumper valves, non-return valves or pressure limiting valves in the branches or primary flow and return lines between the heat pump and tanks **WILL** affect performance of the heat pump.

- b. Refrigerant charge too high
- c. Refrigerant charge too low?

Turn heat pump off then on again at circuit breaker to reset system.

- **Heat pump compressor excessively noisy**

Check for correct phase rotation (refer to [page 43](#)).

AUTOMATIC DEFROST

The Rheem Commercial Heat Pump installation can be configured in a number of ways depending on the requirements of the individual installation.

Ice may begin to form on the evaporator when the air temperature falls below 7°C, and this will reduce the heat pump efficiency. The water heating system can be designed to operate in one of two modes when ambient temperature falls below 7°C.

In defrost mode the heat pump will use hot gas injection to melt any ice that may form on the evaporator coil when operating at air temperatures below 7°C.

In auxiliary heating mode the controller deactivates the heat pump and switches to an auxiliary gas or electric water heater. A pump circulates water from the storage tanks through the auxiliary water heater, if installed, until the set temperature of 60°C is reached. During this period the evaporator will defrost. The auxiliary heater should be set at 60°C.

For most applications, automatic defrost should be satisfactory to meet the water heating demands.

Defrost Configuration

The wall controller must be configured to allow automatic defrost to occur instead of auxiliary heating.

Adjustments

- Screen normally displays Tank Temperature.
- Press **AMBIENT** button to temporarily view Ambient Temperature.
- To adjust **Set Point**, pressing **UP** or **DOWN** button displays set point for the current view.
- To adjust the **AMBIENT** set point to enable automatic defrost to take precedence, press **DOWN** to adjust set point to **minus 5°C**.
- Press **ACCEPT** to save setting to memory. If no buttons are pressed for 8 seconds settings are not saved and display will revert to show tank temperature.

RHEEM HEAT PUMP WATER HEATER WARRANTY

- AUSTRALIA ONLY -

HEAT PUMP WATER HEATER MODELS 952022, 953022

1. THE RHEEM WARRANTY – GENERAL

- 1.1 This warranty is given by Rheem Australia Pty Limited ABN 21 098 823 511 of 1 Alan Street, Rydalmere New South Wales.
- 1.2 Rheem offer a trained and qualified national service network who will repair or replace components at the address of the water heater subject to the terms of the Rheem warranty. Rheem Service, in addition can provide preventative maintenance and advice on the operation of your water heater. The Rheem Service contact number is available 7 days a week on 131 031 with Service personnel available to take your call from 8am to 8pm daily (hours subject to change).
- 1.3 For details about this warranty, you can contact us on 131 031 or by email at warrantyenquiry@rheem.com.au (not for service bookings).
- 1.4 The terms of this warranty are set out in section 2 and apply to water heaters manufactured after 1st January 2012.
- 1.5 If a subsequent version of this warranty is published, the terms of that warranty will apply to water heaters manufactured after the date specified in the subsequent version.

2. TERMS OF THE RHEEM WARRANTY AND EXCLUSIONS TO IT

- 2.1 The decision of whether to repair or replace a faulty component is at Rheem's sole discretion.
- 2.2 Where a failed component or cylinder is replaced under this warranty, the balance of the original warranty period will remain effective. The replacement does not carry a new Rheem warranty.
- 2.3 Where the water heater is installed outside the boundaries of a metropolitan area as defined by Rheem or further than 25 km from either a regional Rheem branch office or an Accredited Rheem Service Agent's office, the cost of transport, insurance and travelling between the nearest branch office or Rheem Accredited Service Agent's office and the installed site shall be the owner's responsibility.
- 2.4 Where the water heater is installed in a position that does not allow safe or ready access, the cost of that access, including the cost of additional materials handling and/or safety equipment, shall be the owner's responsibility. In other words, the cost of dismantling or removing cupboards, doors or walls and the cost of any special equipment to bring the water heater to floor or ground level or to a serviceable position is not covered by this warranty.
- 2.5 This warranty only applies to the original and genuine Rheem water heater in its original installed location and any genuine Rheem replacement parts.
- 2.6 If the water heater is not sized to supply the hot water demand in accordance with the guidelines in Rheem's water heater literature, any resultant fault will not be covered by Rheem's warranty.
- 2.7 The Rheem warranty does not cover faults that are a result of:
 - a) Accidental damage to the water heater or any component (for example: (i) Acts of God such as floods, storms, fires, lightning strikes and the like; and (ii) third party acts or omissions).
 - b) Misuse or abnormal use of the water heater.
 - c) Installation not in accordance with the Owner's Guide and Installation Instructions or with relevant statutory and local requirements in the State or Territory in which the water heater is installed.
 - d) Connection at any time to a water supply that does not comply with the water supply guidelines as outlined in the Owner's Guide and Installation Instructions.

RHEEM HEAT PUMP WATER HEATER WARRANTY -AUSTRALIA ONLY-

- e) Repairs, attempts to repair or modifications to the water heater by a person other than Rheem Service or a Rheem Accredited Service Agent.
 - f) Faulty plumbing or faulty power supply.
 - g) Failure to maintain the water heater in accordance with the Owner's Guide and Installation Instructions.
 - h) Transport damage.
 - i) Fair wear and tear from adverse conditions (for example, corrosion).
 - j) Cosmetic defects.
- 2.8 If you require a call out and we find that the fault is not covered by the Rheem warranty, you are responsible for our standard call out charge. If you wish to have the relevant component repaired or replaced by Rheem, that service will be at your cost.
- 2.9 Subject to any statutory provisions to the contrary, this warranty excludes any and all claims for damage to furniture, carpet, walls, foundations or any other consequential loss either directly or indirectly due to leakage from the water heater, or due to leakage from fittings and/ or pipe work of metal, plastic or other materials caused by water temperature, workmanship or other modes of failure.

3. WHAT IS COVERED BY THE RHEEM WARRANTY FOR THE WATER HEATERS DETAILED IN THIS DOCUMENT

- 3.1 Rheem will repair or replace a faulty component of your water heater if it fails to operate in accordance with its specifications as follows:

What components are covered	The period in which the fault must appear in order to be covered	What coverage you receive
All components	Year 1	Repair and/or replacement of the faulty component, free of charge, including labour.
Sealed System* components (only if the water heater is installed in a single-family domestic dwelling**)	Year 2	Repair and/or replacement of the faulty component, free of charge, including labour.
The cylinder (if the water heater is installed in a single-family domestic dwelling)	Years 2 & 3	Repair and / or replacement of the cylinder, free of charge, including labour.
	Years 4 & 5	Replacement cylinder, free of charge. Installation and repair labour costs are the responsibility of the owner.
The cylinder (if the water heater is <u>not</u> installed in a single-family domestic dwelling)	Years 2 & 3	Replacement cylinder, free of charge. Installation and repair labour costs are the responsibility of the owner.

* The Sealed System includes components that carry refrigerant only, e.g. Compressor, Condenser, TX Valve, Receiver / Drier, Evaporator and associated pipe work.

** Application restrictions do not apply to commercial grade heat pump models 952022 and 953022.

RHEEM HEAT PUMP WATER HEATER WARRANTY -AUSTRALIA ONLY-

4. ENTITLEMENT TO MAKE A CLAIM UNDER THIS WARRANTY

- 4.1 To be entitled to make a claim under this warranty you need to:
- a) Be the owner of the water heater or have consent of the owner to act on their behalf
 - b) Contact Rheem Service without undue delay after detection of the defect and, in any event, within the applicable warranty period.
- 4.2 You are **not** entitled to make a claim under this warranty if your water heater:
- a) Does not have its original serial numbers or rating labels.
 - b) Is not installed in Australia.

5. HOW TO MAKE A CLAIM UNDER THIS WARRANTY

- 5.1 If you wish to make a claim under this warranty, you need to:
- a) Contact Rheem on 131031 and provide owner's details, address of the water heater, a contact number and date of installation of the water heater or if that's unavailable, the date of manufacture and serial number (from the rating label on the water heater)
 - b) Rheem will arrange for the water heater to be tested and assessed on-site.
 - c) If Rheem determines that you have a valid warranty claim, Rheem will repair or replace the water heater in accordance with this warranty
- 5.2 Any expenses incurred in the making of a claim under this warranty will be borne by you.

6. THE AUSTRALIAN CONSUMER LAW

- 6.1 Our goods come with guarantees that cannot be excluded under the *Australian Consumer Law*. You are entitled to a replacement or refund for a major failure and for compensation for any other reasonably foreseeable loss or damage. You are also entitled to have the goods repaired or replaced if the goods fail to be of acceptable quality and the failure does not amount to a major failure.
- 6.2 The Rheem warranty (set out above) is in addition to any rights and remedies that you may have under the *Australian Consumer Law*.

RHEEM AUSTRALIA PTY LTD
A.B.N. 21 098 823 511
www.rheem.com.au

FOR SERVICE TELEPHONE
131 031 AUSTRALIA
0800 657 335 NEW ZEALAND